

## io tavolo datasheet

LED table lamp with spherical head, movable in any direction thanks to Occhio 3D kinematics with two pivots set at an angle of 22.5° to each other; operation via heat-insulated grip pads. Lighting effect can be changed through optional inserts; dichroitic color filters can be additionally inserted. Power 13W or 18W (preselectable), switchable and dimmable by hand movement control via touchless sensor (can be deactivated). Power supply via plug mains adapter (converter); cable in the base can be rolled up. Surface combinations of head, pads, body and base can be configured as desired; pads changeable.

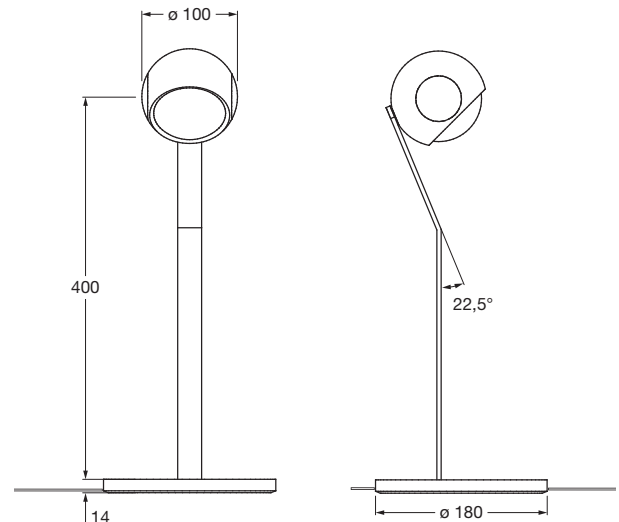

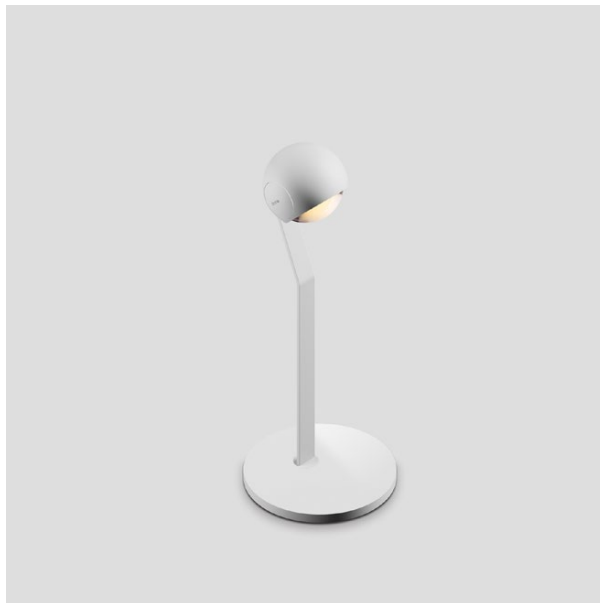

















Dimensions in mm

### technical data io tavolo

properties	material	aluminium, zinc chrome-plated or painted, optical plastic, glass
	turning range head	360°
	turning range body	360° (with stop)
	weight	2.40 kg
surface	head	matt gold, rose gold, bronze, shiny chrome, dark chrome, matt chrome, glossy white, matt white, matt black, phantom, black phantom
	pads	rose gold, bronze, shiny chrome, dark chrome, matt chrome, glossy white, matt white, matt black
	body	shiny chrome, dark chrome, matt chrome, matt white, matt black
	base	shiny chrome, dark chrome, matt chrome, glossy white, matt white, matt black
Occhio LED	average life time	> 50.000 hrs
	energy efficiency class (luminous efficiency)	G (63 lm / W)
	power	LED 18 W (incl. Occhio power supply unit approx. 22 W, standby < 0.5 W) / LED 13 W (incl. Occhio power supply unit approx. 15 W, standby < 0.5 W)
	color rendering index	perfect color; CRI Ra 97      high flux; CRI Ra 85
	color temperature (color consistency)	2700 K, 3000 K (2-step)      3000 K, 3500 K, 4000 K (2-step)
electricity	dimming	by integrated touchless sensor in head
	power supply unit	with integrated converter, cable length 180 cm
	power factor power supply (cos φ1)	0.9
	flicker / stroboscopic effect	1 (PstLM) / 0.9 (SVM)
	permitted operating conditions	ambient temperature 10–30°C, for indoor use only

## io tavolo overview inserts

io head				
satinised glass				
soft edge glass				
fresnel lens				
color filter (optional, power of light source max. 13 W)				
lens				
				
	io C	io C with soft edge glass	io C with satinised glass	io C with fresnel lens

## io tavolo lighting effects

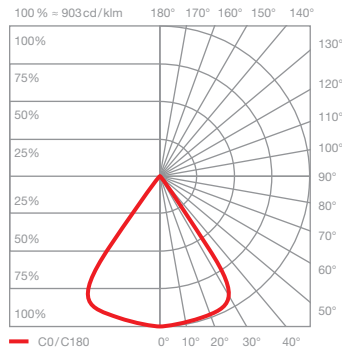
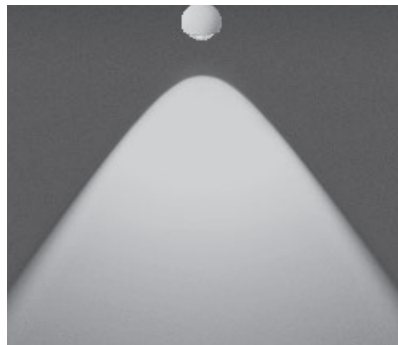

### io C

directed light (approx. 80°)

inserts: lens

luminous flux: perfect color 18W 1170lm  
high flux 18W 1610lm

perfect color 13W 800lm  
high flux 13W 1170lm

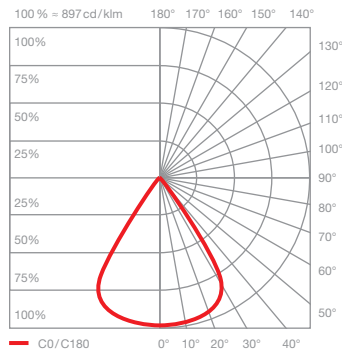
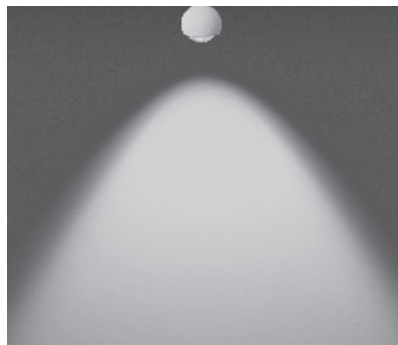

### io C with soft edge glass

directed light with soft contour of the beam angle (approx. 80°)

inserts: lens  
soft edge glass

luminous flux: perfect color 18W 1070lm  
high flux 18W 1470lm

perfect color 13W 740lm  
high flux 13W 1070lm

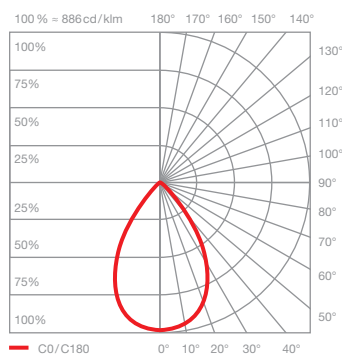
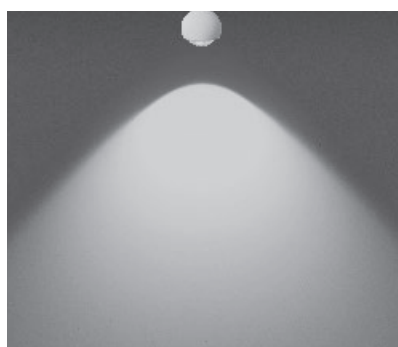

### io C with satinised glass

diffused light with soft widening of the beam angle (approx. 100°)

inserts: lens  
satinised glass

luminous flux: perfect color 18W 910lm  
high flux 18W 1250lm

perfect color 13W 630lm  
high flux 13W 910lm

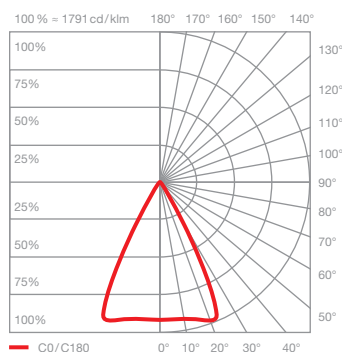
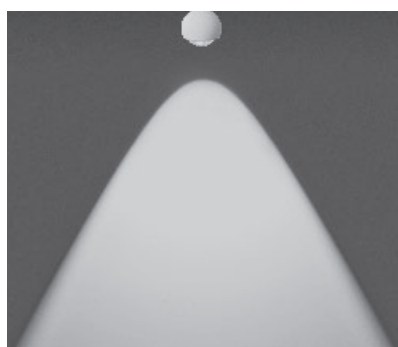

### io C with fresnel lens

bundled light  
beam angle approx. 60°

inserts: lens  
fresnel lens

luminous flux: perfect color 18W 990lm  
high flux 18W 1360lm

perfect color 13W 680lm  
high flux 13W 990lm