

A—N—D

# SPOTLIGHT VOLUMES SERIES CEILING/WALL

DESIGNER  
LUKAS PEET

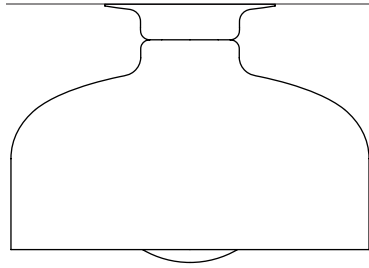

INSTRUCTIONS



SCAN HERE

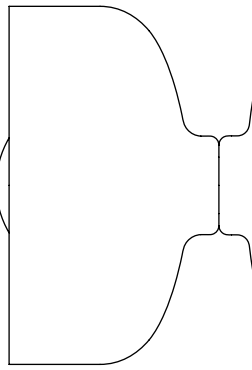

WORLD MARKET



A-N-D.COM

# INSTALLATION NOTES

---

The luminaire is powered by line voltage and is rated for inputs between 220-240VAC.

Lamping is not included. It is recommended that an E27 base, dimmable A19 LED lamp is used with this luminaire.

For questions regarding installation, please email [info@n-d.com](mailto:info@n-d.com)



---

## CARE INSTRUCTIONS

Always wear clean gloves when handling the luminaire.

Clean painted surfaces with a soft, lint-free cloth. Clean glass with a soft lint-free cloth and a standard glass cleaner.

For replacement glass globes, contact A-N-D directly.

Never exceed the recommended max wattage and voltage (12W, 240V) as doing so may damage the luminaire or cause a fire.



---

## WARNING

The luminaire must be installed by a qualified electrician in a dry indoor location.

Failure to meet any or all of these criteria will not only damage the luminaire, but will void both the warranty and all of its certifications.

# COMPONENTS



- ① WIRE NUT (2)
- ② T-BAR (A, B, C, D SHADES)
- ②a MOUNTING PLATE (E SHADE ONLY)
- ③ THREADED ROD
- ④ HEX NUT (3)
- ⑤ SOCKET ASSEMBLY
- ⑥ MACHINE SCREW (2)
- ⑦ CANOPY COVER
- ⑧ LAMP SHADE
- ⑨ GLASS HOLDER  
\*A+B+E SHADE ONLY
- ⑩ SOCKET RING
- ⑪ A19 LAMP ( NOT INCLUDED)
- ⑫ GLASS GLOBE  
\*A+B+E SHADE ONLY

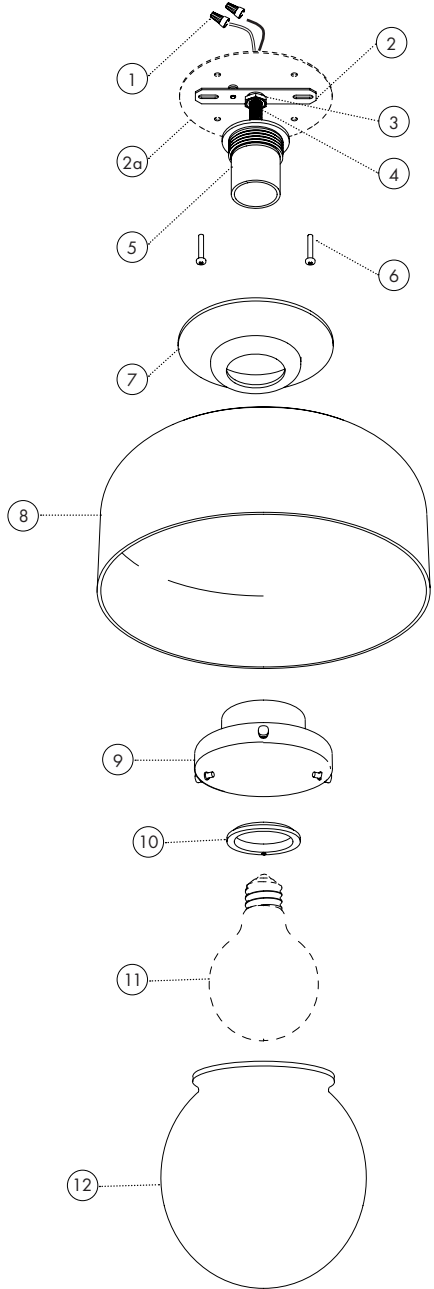

# SPOTLIGHT OPTIONS

---

The series can be mounted two ways, either on the ceiling or on the wall.

There are 5 sizes for the Spotlight Ceiling.

**A**

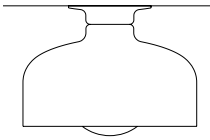

27cm | 10.5"

**B**

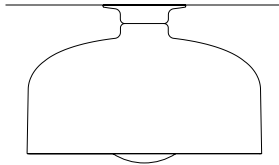

36cm | 14"

**C**

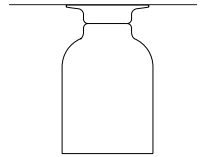

14cm | 5.5"

**D**

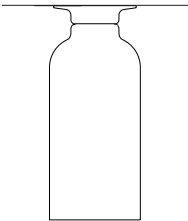

14cm | 5.5"

**E**

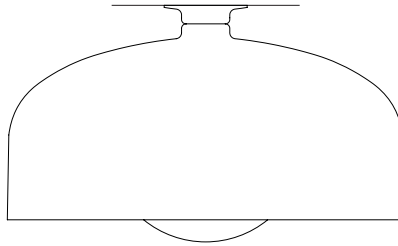

61cm | 24"

There are 4 sizes for the Spotlight Wall.

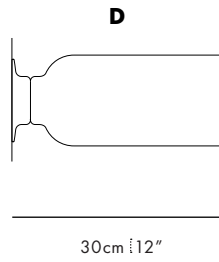
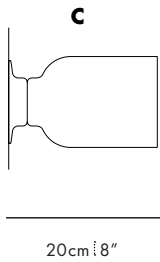
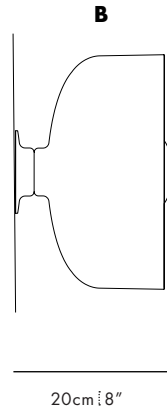
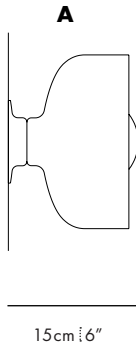

# INSTALLATION

## STEP 1

### Adjust T-bar position.

Socket assembly must be positioned 18mm from ceiling or wall surface.

When T-bar is correctly positioned, the canopy will sit flush against socket assembly and wall/ceiling surface.

Tighten the hex nuts until spinning of T-bar is prevented.

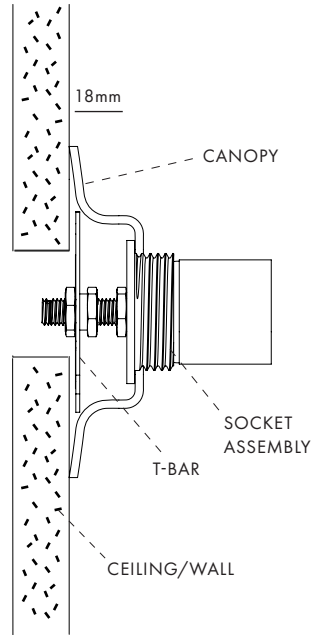

## STEP 2

**Connect the luminaire to input power. Connect ground.**

Black/brown wire = **Line** (L)

White/blue wire = **Neutral** (N)

Green screw = **Ground** (G)

**⚠ Caution!**  
Ensure that the power  
is disconnected.

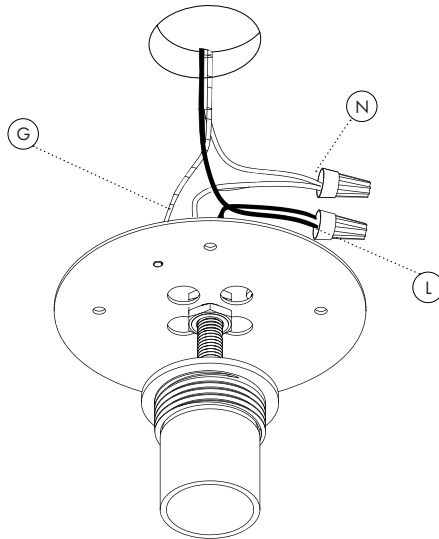

# INSTALLATION

## STEP 3

**Attach the T-bar/mounting plate to the ceiling or wall.**

Use the provided #8 screws.  
Anchors, if needed, to be provided by installer.

Tighten until the T-bar is pressed securely and firmly against the ceiling or wall.

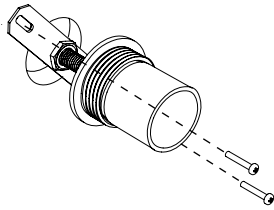

**\*FOR A, B, C, D SHADES**

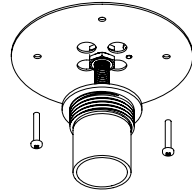

**\*FOR E SHADE ONLY**

## STEP 4

**Slide the canopy over the socket assembly.**

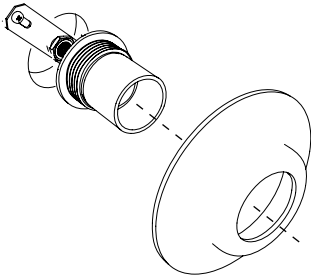

**\*FOR A, B, C, D SHADES**

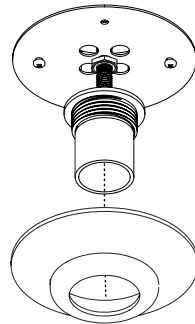

**\*FOR E SHADE ONLY**

---

**STEP 5**

**Slide lamp shade,  
globe holder (if  
applicable) over the  
socket assembly.**

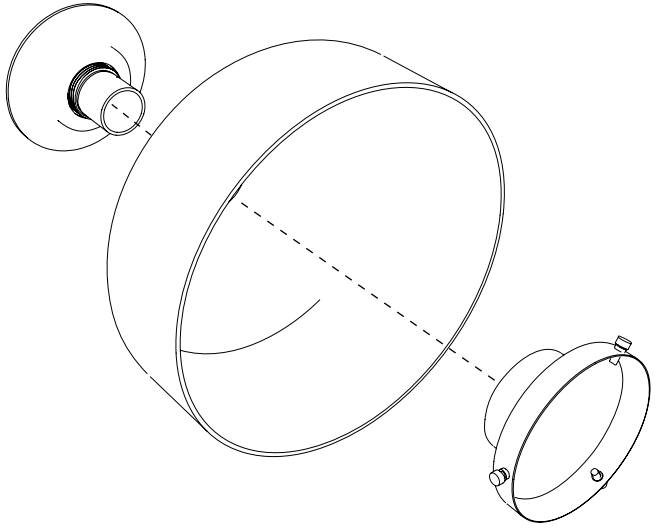



---

**STEP 6**

**Secure the assembly  
in position.**

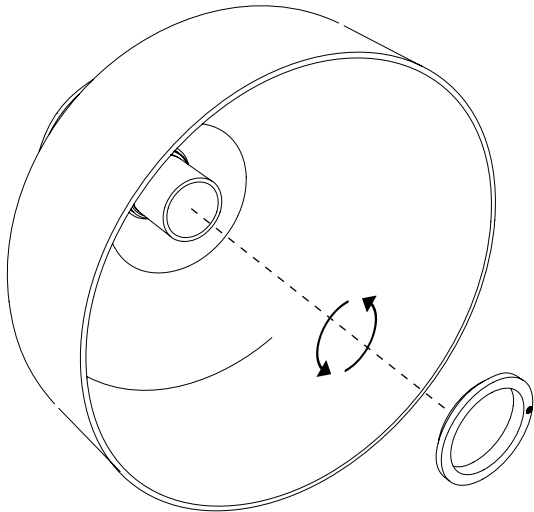
Turn the socket ring clockwise  
on the socket assembly until all  
parts are tight.



# INSTALLATION

---

## 6A

Use the hex key to aid in turning the socket ring until the assembly is tight. Space for assembly is limited, the hex key provides extra grip needed to spin and tighten the socket ring.

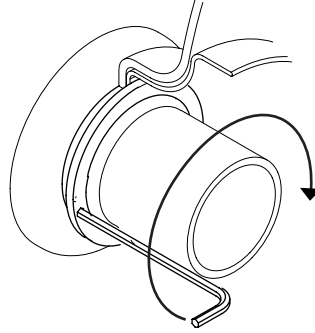

---

## 6B

Use the hex key to tighten down the setscrew. This prevents the assembly from becoming loose in the future.

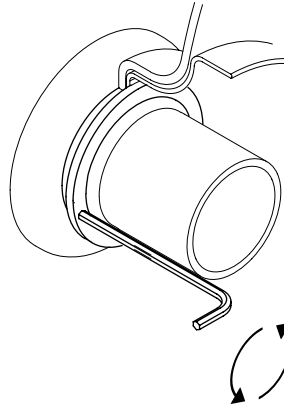

---

## STEP 7

### Install lamping.

Turn the lamp clockwise into the socket.

If the lamp does not turn on when the power is reconnected, try threading the lamp further into the lamp socket.

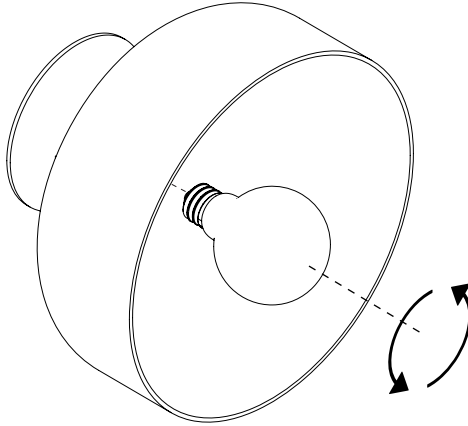



---

## STEP 8

### Install the glass globe, (A + B + E Shade only).

Turn the screws on the side of the globe holder until the glass globe is securely held in place.

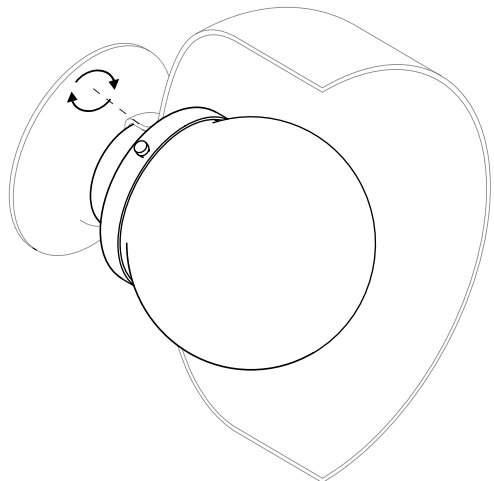
For replacement glass globes, contact A-N-D directly.



# A—N—D

For support, please contact:

[info@a-n-d.com](mailto:info@a-n-d.com)

+1 604 563 6938



1951 Franklin St,  
Vancouver, BC  
Canada V5L 0C7

**A-N-D.COM**