

Sento tavolo datasheet

LED table or floor luminaire, connection via power supply unit (converter) with wall plug. Modular LED head-body-system allows free combination of different surfaces of head, body and base. Removable head for configuration and maintenance purposes, LED changeable. Heads available with one sided or double sided light output, power of light source 18W.

Lighting effect changeable by using optional inserts, dichroic color filters can be added. Adjustment via heat-decoupled carbon pin (fixation of head against rotation optional). Switch- and dimmable via »touchless control« with gestures at the head.

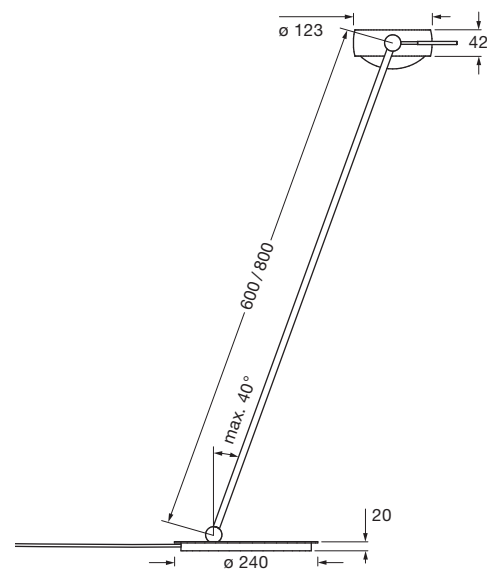













































dimensions in mm

technical data Sento tavolo

properties	material	aluminium, steel chrome-plated, painted or anodised, plastic, glass, optical plastic
	length	600 / 800 mm
	swivel range, rotation head	max. 40°, 360°
	weight	6.5 kg
surface	head	matt gold, rose gold, bronze, shiny chrome, dark chrome, matt chrome, glossy white, matt white, matt black, phantom, black phantom
	body	matt white, matt black, shiny chrome, dark chrome, matt chrome
	base	shiny chrome, dark chrome, glossy white, matt chrome, matt white, matt black
	cable	matt white, matt black, transparent
Occhio LED	average life time	> 50.000 hrs
	energy efficiency class (luminous efficiency)	G (head single sided 62 lm/W, head double sided 69 lm/W)
	power	LED 18 W (incl. Occhio power supply unit approx. 22 W, standby < 0.5 W)
	color rendering index	perfect color; CRI Ra 97 high flux; CRI Ra 85
	color temperature (color consistency)	2700, 3000 K (2-step) 3000, 3500, 4000 K (2-step)
electricity	dimming	»touchless control« and Occhio air (optional)
	power supply plug unit	with integrated converter, cable length 180 cm, for use with 230 V AC
	power factor power supply (cos φ1)	0.9
	flicker / stroboscopic effect	1 (PstLM) / 0.9 (SVM)
	permitted operating conditions	ambient temperature 10–30°C, for indoor use only

Sento tavolo overview inserts

single-sided head				
spot lens				
satinised glass (optional)				
soft edge glass (optional)				
fresnel lens				
color filter (optional, power of light source max. 18 W)				
diffuser glass				
lens				
				
	Sento B	Sento C	Sento S30	Sento S40
lens				
diffuser glass				
color filter (optional, power of light source max. 18 W)				
soft edge glass (optional)				
satinised glass (optional)				
double-sided head				
satinised glass (optional)				
soft edge glass (optional)				
color filter (optional, power of light source max. 18 W)				
diffuser glass				
lens				
				
		Sento A	Sento D	Sento E

Sento tavolo lighting effects

 head single sided

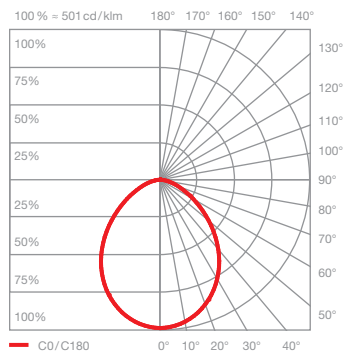
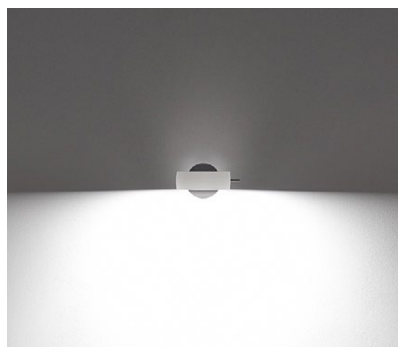

Sento B

diffuse light

insert: diffusor glass

luminous flux: perfect color 18 W 1000lm
high flux 18 W 1370lm

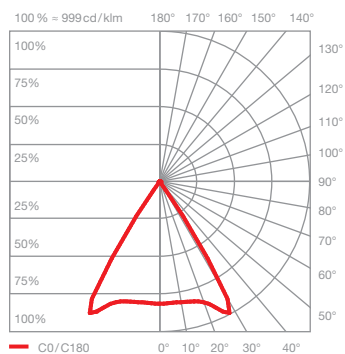

Sento C

directed light
beam angle approx. 80°

insert: lens
luminous flux: perfect color 18 W 1140lm
high flux 18 W 1570lm

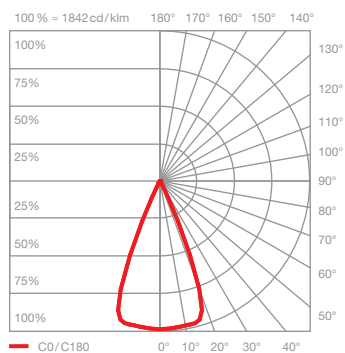
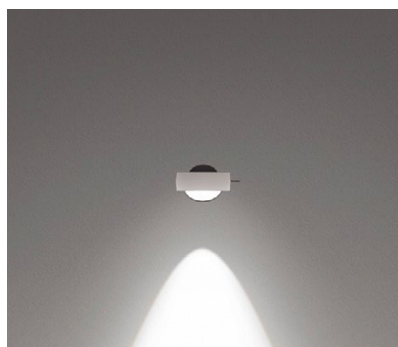

Sento S40

directed light
beam angle approx. 40°

insert: spot lens, lens
soft edge glass

luminous flux: perfect color 18 W 1130lm
high flux 18 W 1560lm

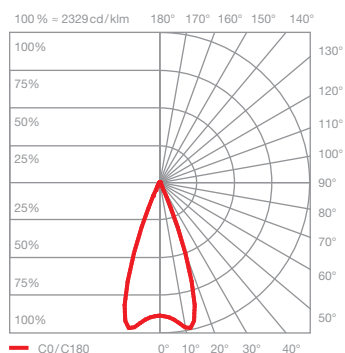

Sento S30

directed light
beam angle approx. 30°

insert: spot lens, lens
fresnel lens

luminous flux: perfect color 18 W 1110lm
high flux 18 W 1530lm

Sento tavolo lighting effects

 head double sided

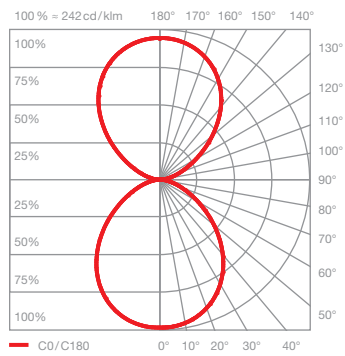
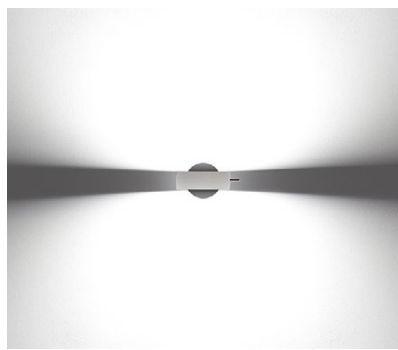

Sento A

diffuse light in both directions

insert: diffuser glass
diffuser glass

luminous flux: perfect color 18 W 1090 lm
high flux 18 W 1500 lm

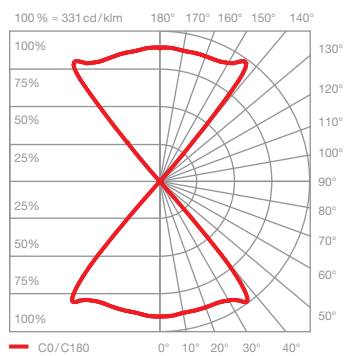

Sento D

directed light in both directions
beam angle approx. 80°

insert: lens
lens

luminous flux: perfect color 18 W 1270 lm
high flux 18 W 1750 lm

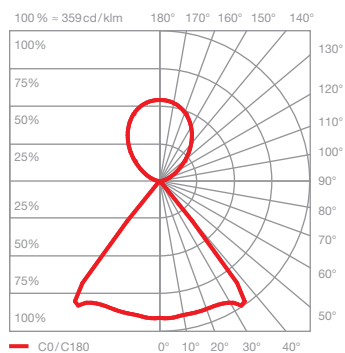
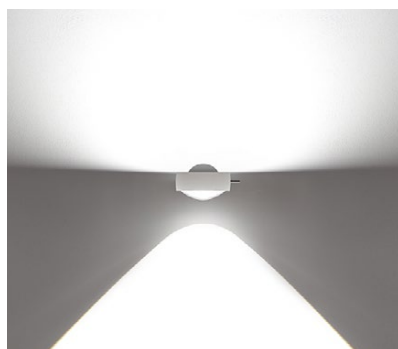

Sento E

diffuse up light
directed down light
beam angle approx. 80°

insert: diffuser glass
lens

luminous flux: perfect color 18 W 1170 lm
high flux 18 W 1620 lm