

## Sento verticale up datasheet

LED wall mounted luminaire with a high base, in which the power supply unit (converter) is included for mounting on fixed ceiling or wall, connection to 230V. Modular LED head-body-system allows free combination of different surfaces of head, body and base. Removable head for configuration and maintenance purposes, LED changeable. Heads available with one sided or double sided light output, power of light source 18W or 26W.

Lighting effect changeable by using optional inserts, dichroic color filters can be added. Adjustment via heat-decoupled carbon pin (fixation of head against rotation optional). Dimmable via external trailing edge phase-cut dimmer or via »touchless control« with gestures at the head.

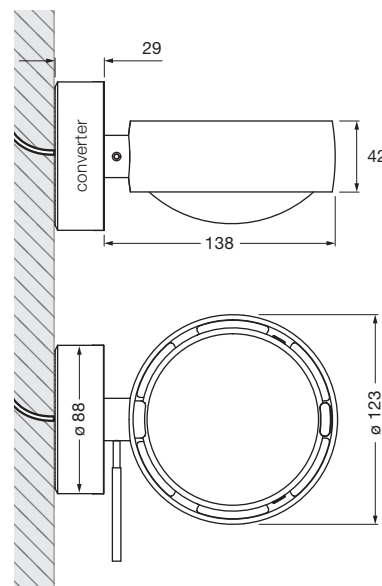













































dimensions in mm

### technical data Sento verticale up

properties	material	aluminium, steel chrome-plated, painted or anodised, plastic, glass, optical plastic
	length	138 mm including head
	rotation head	360°
	weight	1.4 kg
surface	head	matt gold, rose gold, bronze, shiny chrome, dark chrome, matt chrome, glossy white, matt white, matt black, phantom, black phantom
	body	matt white, matt black, shiny chrome, dark chrome, matt chrome
	base	shiny chrome, dark chrome, glossy white, matt chrome, matt white, matt black
Occhio LED	average life time	> 50.000 hrs
	energy efficiency class (luminous efficiency)	G (head single sided 62 lm/W, head double sided 69 lm/W)
	power single sided / double sided	LED 26 W (incl. Occhio power supply unit approx. 30 W, standby < 0.5 W) / LED 18 W (incl. Occhio power supply unit approx. 22 W, standby < 0.5 W)
	color rendering index	perfect color; CRI Ra 97      high flux; CRI Ra 85
	color temperature (color consistency)	2700, 3000 K (2-step)      3000, 3500, 4000 K (2-step)
electricity	dimming	»touchless control« and Occhio air (optional) or via trailing-edge phasecut dimmer* (depends on driver)
	power supply unit	integrated, for use with 230 V AC
	power factor power supply (cos φ1)	0.9
	flicker / stroboscopic effect	1 (PstLM) / 0.9 (SVM)
	permitted operating conditions	ambient temperature 10–30°C, for indoor use only

\* For a list of compatible dimmers, see [www.occhio.com/dim\\_en](http://www.occhio.com/dim_en), trailing-edge phasecut dimmer and Occhio air not combinable

## Sento verticale up overview inserts

single-sided head				
spot lens				
satinised glass (optional)				
soft edge glass (optional)				
fresnel lens				
color filter (optional, power of light source max. 18 W)				
diffuser glass				
lens				
				
	<b>Sento B</b>	<b>Sento C</b>	<b>Sento S30</b>	<b>Sento S40</b>
lens				
diffuser glass				
color filter (optional, power of light source max. 18 W)				
soft edge glass (optional)				
satinised glass (optional)				
double-sided head				
satinised glass (optional)				
soft edge glass (optional)				
color filter (optional, power of light source max. 18 W)				
diffuser glass				
lens				
				
		<b>Sento A</b>	<b>Sento D</b>	<b>Sento E</b>

## Sento verticale up lighting effects

 head single sided

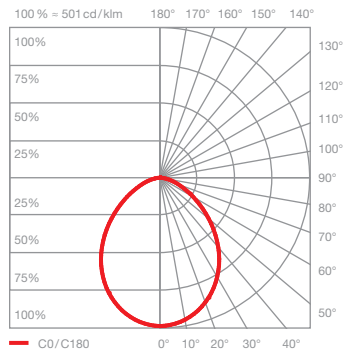
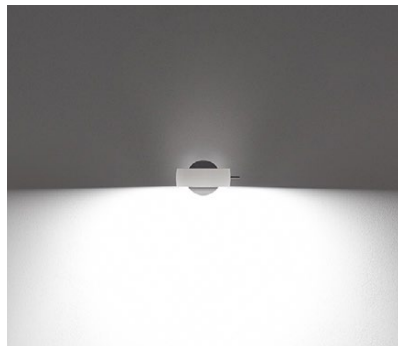

### Sento B

diffuse light

insert: diffusor glass

luminous flux:	perfect color	26 W	1370lm
	high flux	26 W	1870lm
	perfect color	18 W	1000lm
	high flux	18 W	1370lm

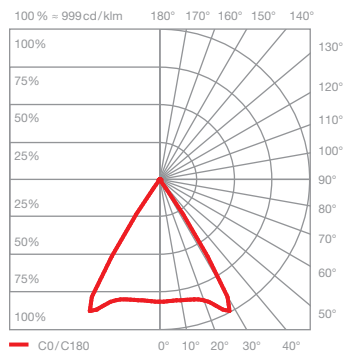

### Sento C

directed light  
beam angle approx. 80°

insert:	lens		
luminous flux:	perfect color	26 W	1570lm
	high flux	26 W	2150lm
	perfect color	18 W	1140lm
	high flux	18 W	1570lm

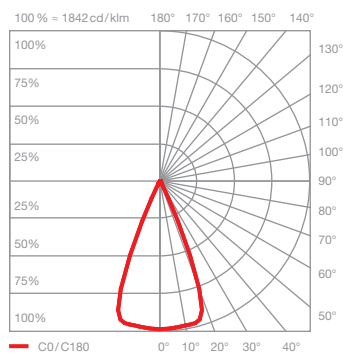
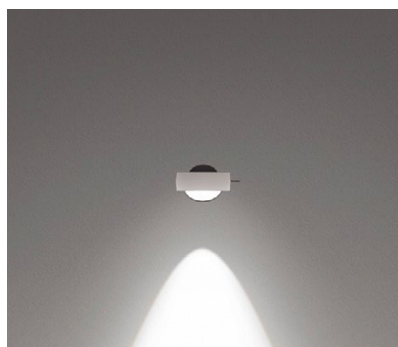

### Sento S40

directed light  
beam angle approx. 40°

insert:	spot lens, lens soft edge glass		
luminous flux:	perfect color	26 W	1560lm
	high flux	26 W	2130lm
	perfect color	18 W	1130lm
	high flux	18 W	1560lm

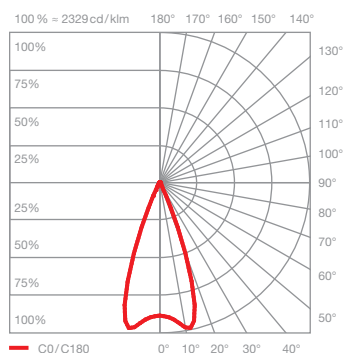

### Sento S30

directed light  
beam angle approx. 30°

insert:	spot lens, lens fresnel lens		
luminous flux:	perfect color	26 W	1530lm
	high flux	26 W	2080lm
	perfect color	18 W	1110lm
	high flux	18 W	1530lm

## Sento verticale up lighting effects

 head double sided

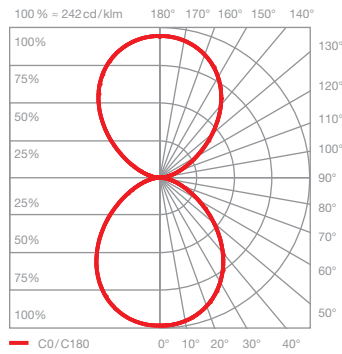
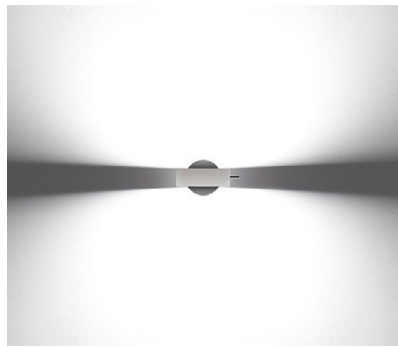

### Sento A

diffuse light in both directions

insert: diffuser glass  
diffuser glass

luminous flux:	perfect color	26 W	1500 lm
	high flux	26 W	2040 lm
	perfect color	18 W	1090 lm
	high flux	18 W	1500 lm

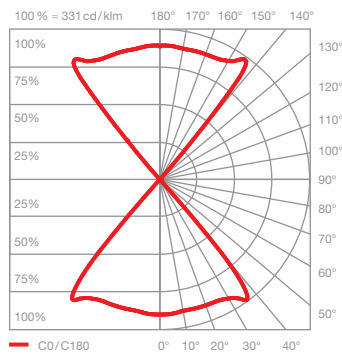

### Sento D

directed light in both directions  
beam angle approx. 80°

insert: lens  
lens

luminous flux:	perfect color	26 W	1750 lm
	high flux	26 W	2390 lm
	perfect color	18 W	1270 lm
	high flux	18 W	1750 lm

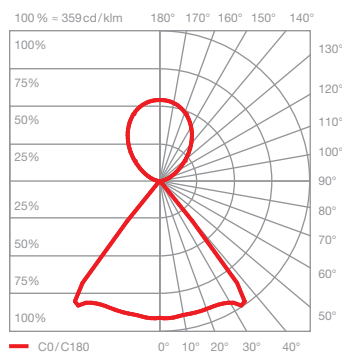
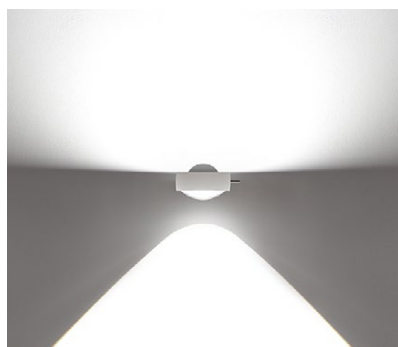

### Sento E

diffuse up light  
directed down light  
beam angle approx. 80°

insert: diffuser glass  
lens

luminous flux:	perfect color	26 W	1620 lm
	high flux	26 W	2200 lm
	perfect color	18 W	1170 lm
	high flux	18 W	1620 lm