

PIPELINE 40 — P

A—N—D

PENDANT

Designed by Caine Heintzman

2013

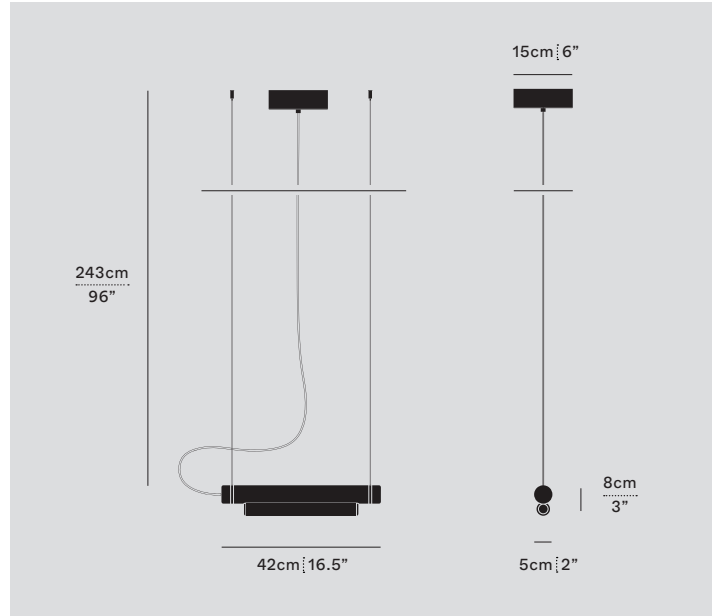

PIP-40-P-BK-27-ELV-120

A-N-D.COM

TYPE

Pendant

DIMENSIONS

42cm x 8cm x 5cm / 16.5" x 3" x 2"

Adjustable drop length

243cm / 96" — Custom length available

3D MODELS ON A-N-D.COM

REVIT, IES, DWG, 3DS, Rhino, Sketchup

CERTIFICATIONS



Application: dry indoor location only

TECHNICAL INFORMATION

Input Voltage

110–120V, 220–240V, 110–277V

Lamping

Integral 5W 24V DC LED

CRI 90+, 50,000 hours

Lumens

239 lumens delivered

Controls

Phase dimming, 0-10V, DALI

COLOUR TEMPERATURE OPTIONS

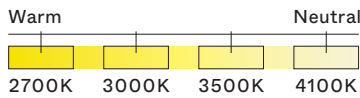

DIM TO WARM



MANUFACTURED

Canada

MATERIALS

Aluminum, Acrylic

FINISHES



Black (BK) White (WH) Raw (RA)



Brass (BR) Copper (CP) Chrome (CH)



For custom finishes, please inquire.

SERIES	SIZE	TYPE	BODY FINISH	END CAP/JOINER	CCT	PS	VOLTAGE IN
PIP	40	P	<input type="checkbox"/> BK (BLACK)	<input type="checkbox"/> BK (BLACK)	<input type="checkbox"/> 27 (2700K)	<input type="checkbox"/> ELV	<input type="checkbox"/> 120
			<input type="checkbox"/> WH (WHITE)	<input type="checkbox"/> WH (WHITE)	<input type="checkbox"/> 30 (3000K)	<input type="checkbox"/> 010	<input type="checkbox"/> 230
			<input type="checkbox"/> RA (RAW)	<input type="checkbox"/> BR (BRASS)	<input type="checkbox"/> 35 (3500K)	<input type="checkbox"/> DAL	<input type="checkbox"/> 277*
			<input type="checkbox"/> BR (BRASS)	<input type="checkbox"/> CP (COPPER)	<input type="checkbox"/> 41 (4100K)		
			<input type="checkbox"/> CP (COPPER)	<input type="checkbox"/> CH (CHROME)	<input type="checkbox"/> DW (DIM TO WARM)		
			<input type="checkbox"/> CH (CHROME)				

*277 only available with 010