

BROKIS®

OVERLAY

CM20065

WALL M - PC1407



Download

COMPONENTS INCLUDED WITH UNIT:

1× light
1× light source
2× hand screw M4×16
1× hex key size 3
1× template
2× threaded L hook
2× wall plug
1× pair cotton gloves
1× installation manual

WARNING:

Installation must be carried out by a qualified electrician only.

Switch off power at main circuit panel prior to installation!

The manufacturer assumes no liability for damage occurring in transport or resulting from incorrect installation.

Installation time: 30 minutes / 2 persons



BROKIS®

BROKIS S.R.O.
ŠPANIĚLOVA 1315/25
163 00 PRAHA 6 - ŘEPY
CZECH REPUBLIC

ORG. ID 64940799
VAT ID CZ64940799
C 42174 MĚSTSKÝ SOUD
V PRAZE

TEL +420 567 211 517
TECHNICAL@BROKIS.CZ
INFO@BROKIS.CZ
WWW.BROKIS.COM



CLEANING THE GLASS

BROKIS upholds only the highest possible quality standards. Prior to shipping, the light undergoes several quality controls and stages of cleaning. Because transportation, storage, and the amount of time that passes between packing at our plant and subsequent unpacking by the client can affect the light in different ways, we strongly recommend cleaning it prior to assembly.

The glass must first be rinsed in warm water, and a dish detergent may be used to remove all foreign particles, dust, and grease. Repeat the process if necessary and then dry the glass thoroughly with a paper towel.

Recommendation: Do not use mineral spirits, highly concentrated thinners, or other substances not intended for use on glass surfaces. Do not use any cleaning agents containing silicone, as they may leave a film and attract dust and smudges.

PRIOR TO SHIPPING, THE FUNCTIONALITY OF EACH LIGHT AND ITS COMPONENTS IS CHECKED THOROUGHLY. THE MANUFACTURER ASSUMES NO LIABILITY FOR THE MISHANDLING OF PRODUCTS.



1. INSTALLING THE GLASS SHADE

Position the glass shade on the concrete base with the holes facing down and use the supplied M4×16 handscrews screws to secure it in place.

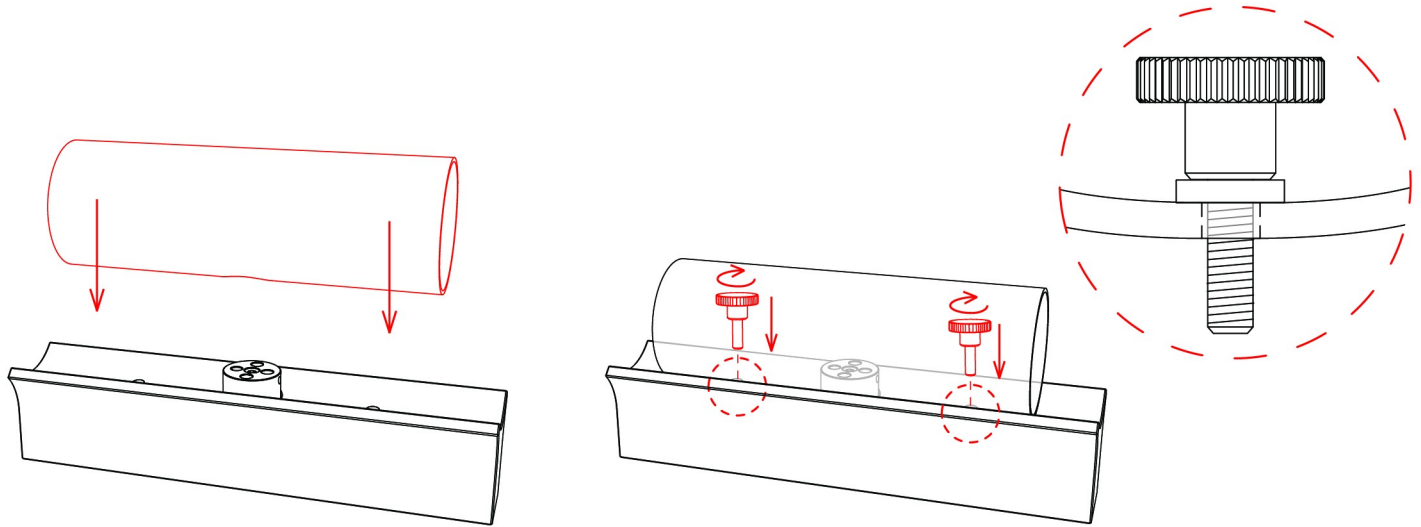

2. INSTALLING THE LIGHT SOURCE 1/2

Before inserting the light source into the glass shade, check the position of the pins on the light source and in the fixture. Ensure that the larger pin on the light source aligns with the larger hole in the connector socket.

Insert the light source into the glass shade. Hold it firmly at both ends and position it over the connector socket. Proceed carefully and press the light source evenly until it is properly seated in the socket.

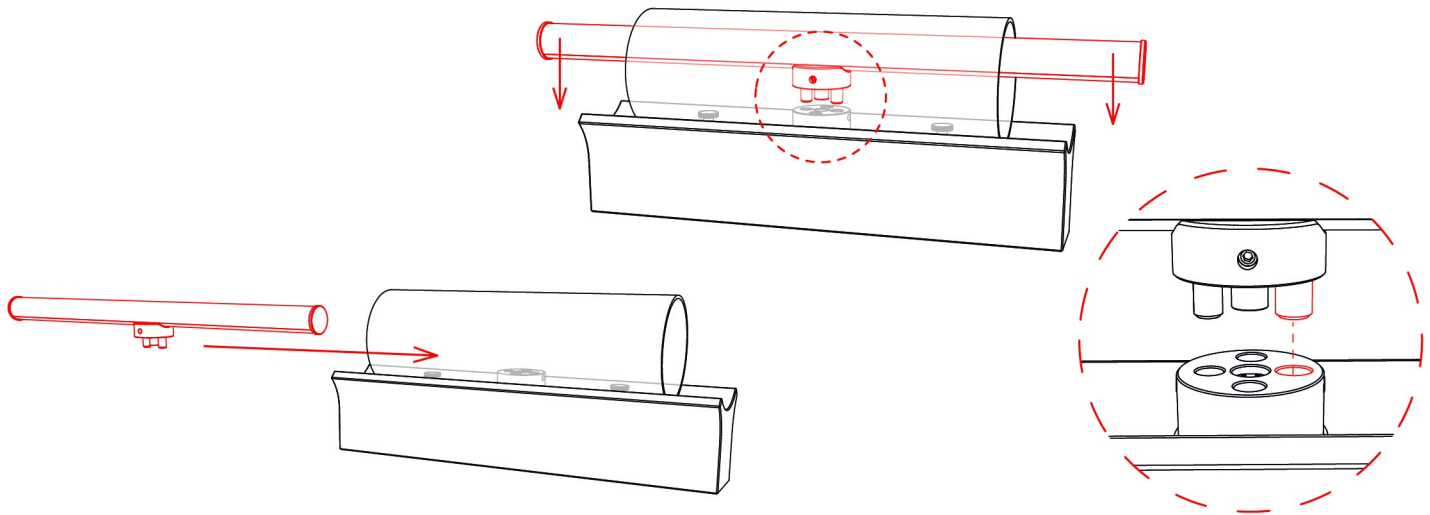

3. INSTALLING THE LIGHT SOURCE 2/2

Using the supplied hex key, tighten the set screw, first on one side of the socket and then on the other.

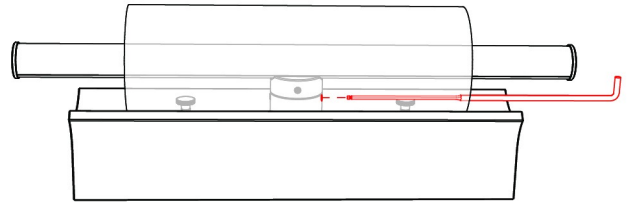
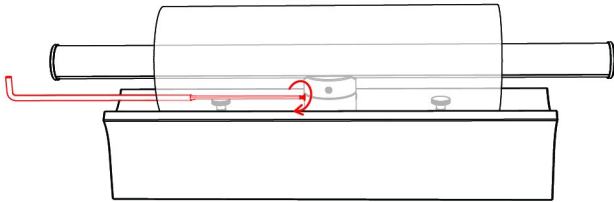

4. MARKING DRILL POINTS

Place the paper template on the wall in the desired position:

- 1 - vertical
- 2 - horizontal

Using a pencil, mark the two drill points on the wall depending on the position of the light.

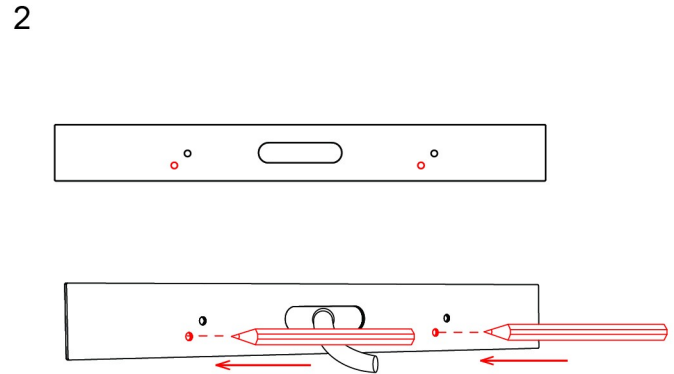
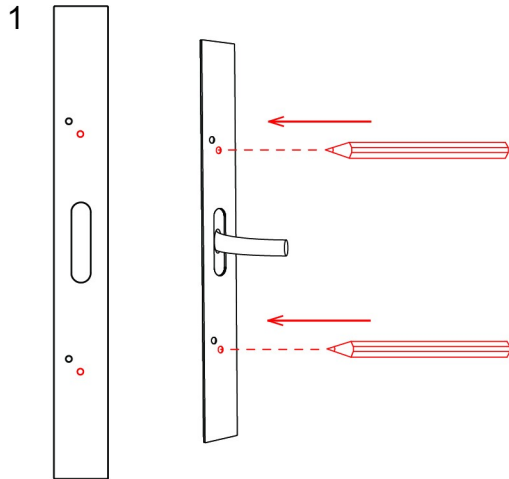

5. INSTALLING THE ANCHORS

With regard to various types of walls and materials, we recommend consulting installation with an expert.
The manufacturer assumes no liability for incorrect installation or defects in the material in which the anchors are installed.

Once the holes have been drilled, insert wall plugs and then screw the L hooks into them.

- 1 - vertical
- 2 - horizontal

1

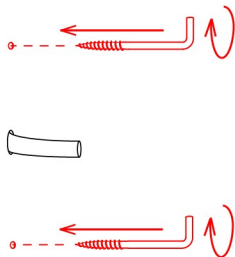

2

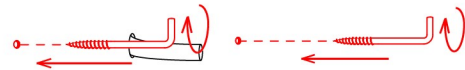

6. CONNECTING THE LIGHT TO THE BUILDING WIRING

With an assistant holding the light, connect it to the building wiring according to the diagram.

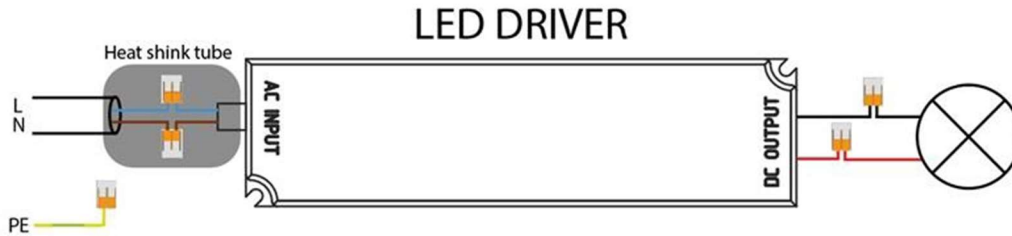

7. INSTALLING THE LIGHT

Position the light on the L hooks in the wall and then pull it gently downwards to secure it in place.

- 1 - vertical
- 2 - horizontal

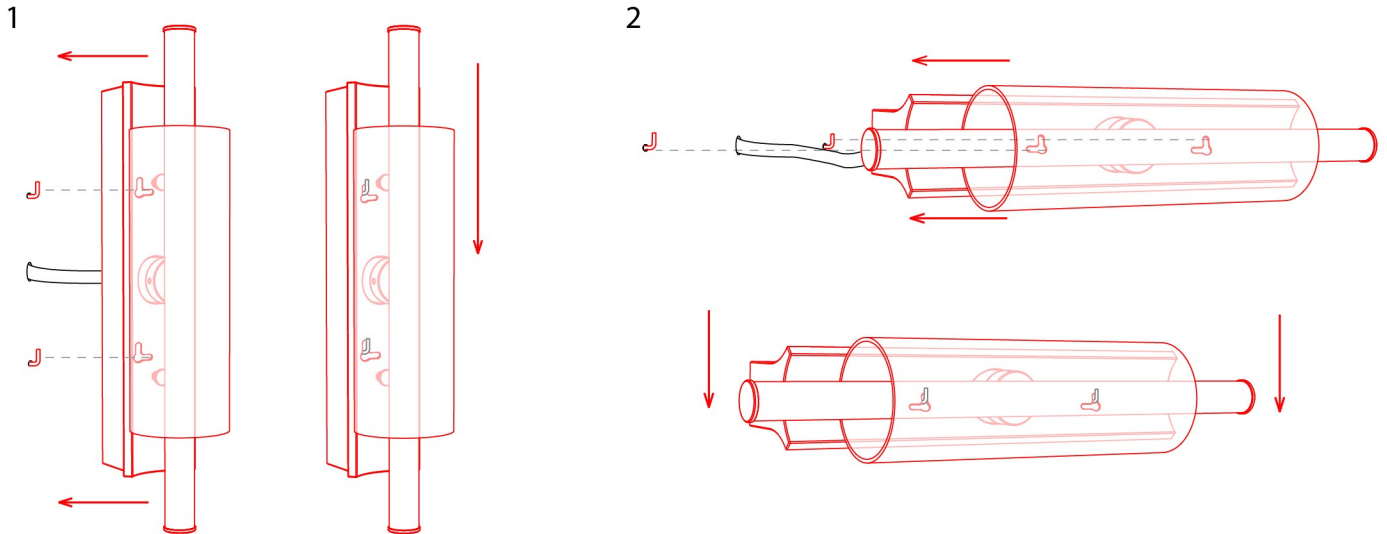

8. SWITCHING ON THE LIGHT

Restore power at the main circuit panel and verify that the light works properly.

1 - vertical

2 - horizontal

1

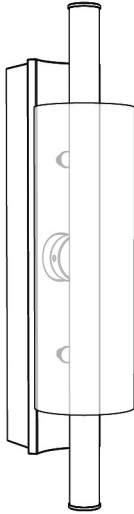

2

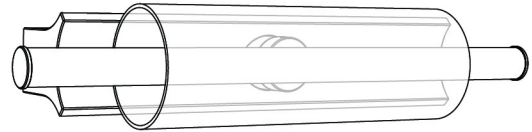

9. REMOVING THE LIGHT SOURCE 1/2

Using the supplied hex key, loosen the set screw, first on one side of the socket and then on the other.

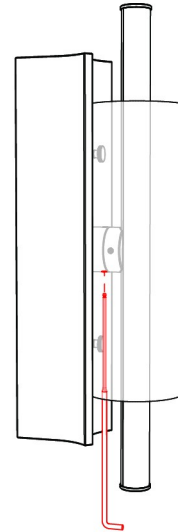
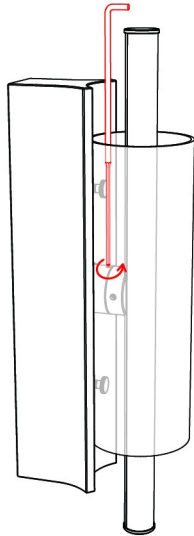

10. **REMOVING THE LIGHT SOURCE 2/2**

Hold the light source firmly at both ends and gently lift to release it. Then slide it out of the glass shade.

