

INSTALLATION MANUAL

IVY HORIZONTAL PC1069

Pendent light



COMPONENTS OF PACKAGING:

1 ceiling canopy with electronics, 2 set screws M5x20, 1 IVY light body, 1 power cable, 1 wire rope stop, 1 wire rope, 7 LED light sources, 7 glass shades, 1 hex key size 1.5, 1 hex key size 2.5, 1 pair cotton gloves, 1 installation manual

WARNING:

Installation must be carried out by a qualified electrician only.

Switch off power at main circuit panel prior to installation!

The manufacturer assumes no liability for damage occurring in transport or resulting from incorrect installation.

Installation time: 45min. / 2 Persons



BROKIS

BROKIS S.R.O.
ŠPANIĚLOVA 1315/25
163 00 PRAHA 6 - ŘEPY
CZECH REPUBLIC

ORG. ID 64940799
VAT ID CZ64940799
C 42174 MĚSTSKÝ SOUD
V PRAZE

TEL +420 567 211 517
TECHNICAL@BROKIS.CZ
INFO@BROKIS.CZ
WWW.BROKIS.CZ

PAGE 3

1. INSTALLING THE CEILING CANOPY BRACKET

Use anchors of sufficient strength (not included). With regard to various types of ceilings, we recommend consulting installation with an expert. The manufacturer assumes no liability for incorrect installation, the use of improper anchors, or defects in the material to which the bracket is secured.

Secure the bracket to the ceiling.

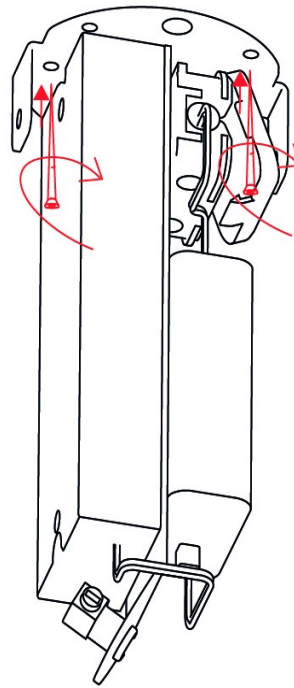

2. INSTALLING THE POWER CABLE

Pass the power cable through the glass ceiling canopy, the grommet, and the plastic cable stop in the bracket. Next, tighten the set screw in the plastic cable stop using at least 1–1.5 Nm of force.

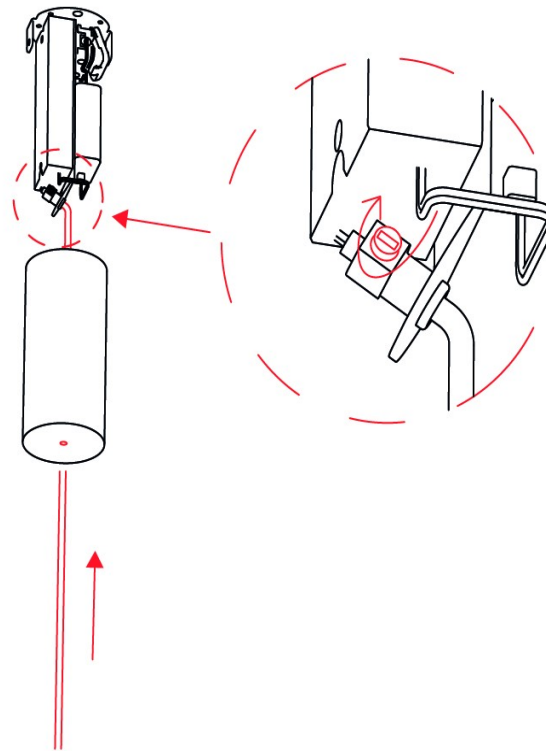

3. INSTALLING THE WIRE ROPE AND WIRE ROPE STOP

Pass the wire rope through the first part of the load-bearing component, the so-called safety. Unscrew the second part of the load-bearing component and slide it over the wire rope (ensure the end of the wire rope is not frayed). Press the two parts together to secure the wire rope. Next, pass the wire rope through the hole in the side of the load-bearing component. Never trim the wire rope before completing installation. Adhering to these steps ensures safe anchoring of the wire rope.

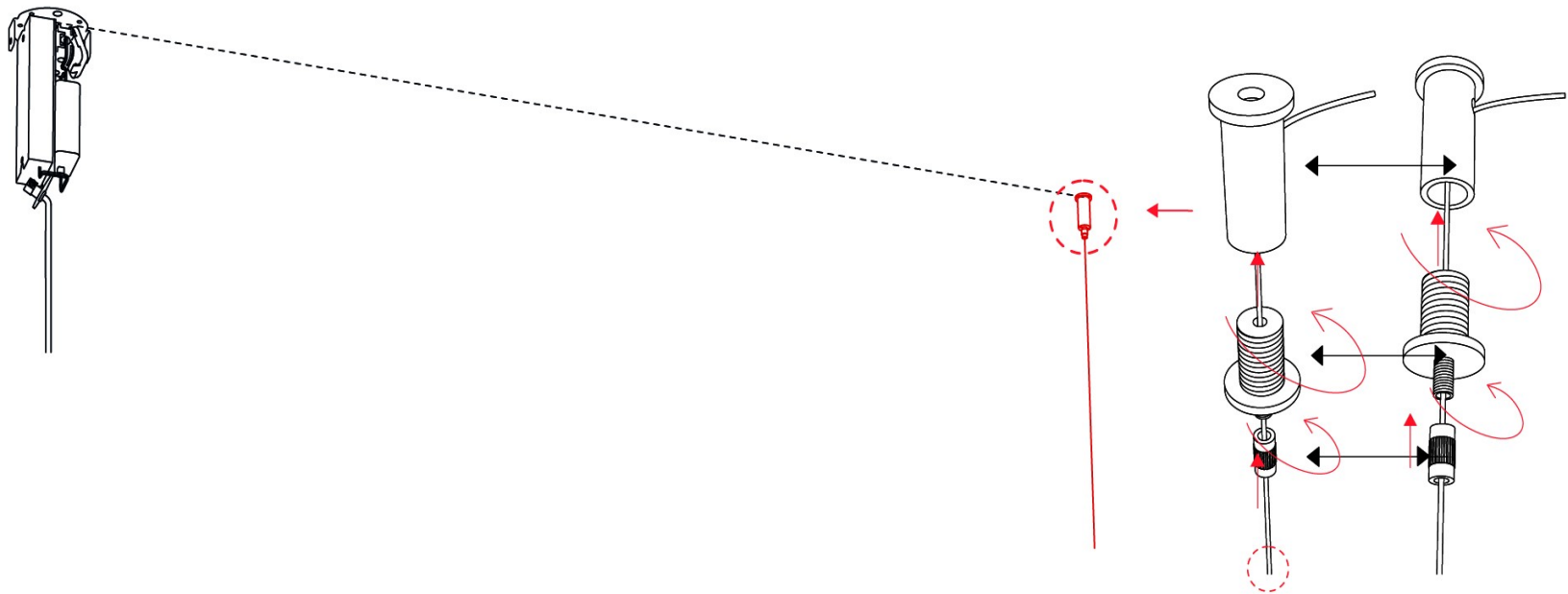

4. CONNECTING THE LIGHT TO THE BUILDING WIRING

Connect the light to the building wiring according to the connection diagram. Care must be taken to ensure the individual wires are stowed in the terminal box.

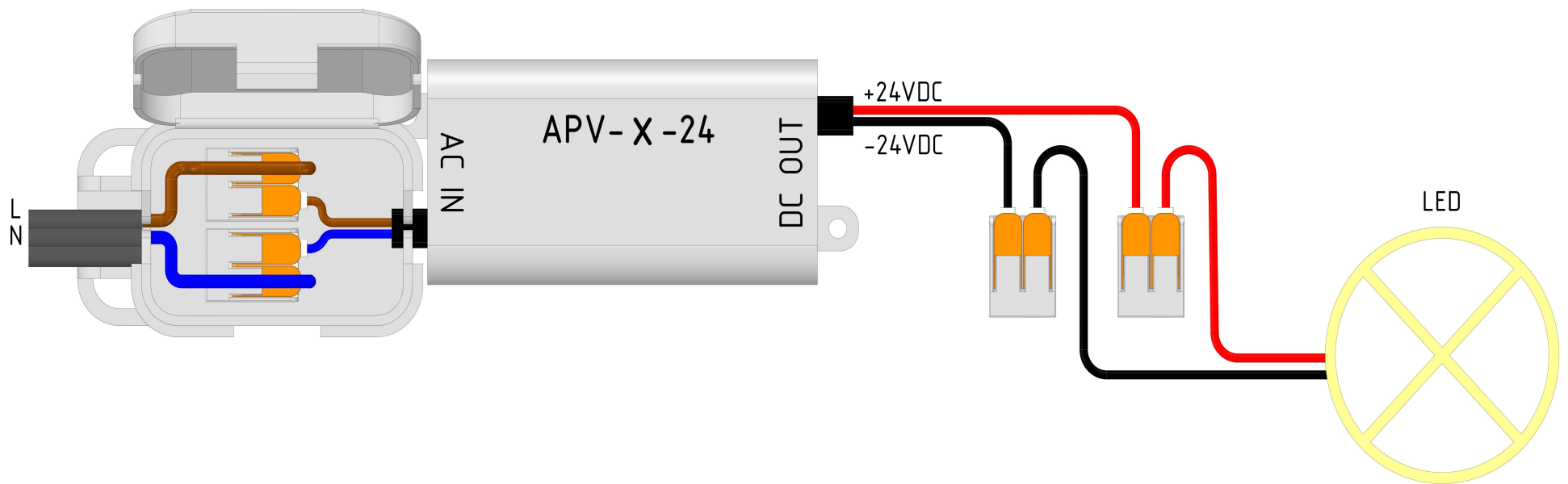

5. INSTALLING THE CEILING CANOPY

Position the ceiling canopy on the bracket and secure by tightening the set screws (M5x25) with the hex key size 2.5. Do not tighten the screws completely – they should extend from the ceiling canopy by at least 5 mm.

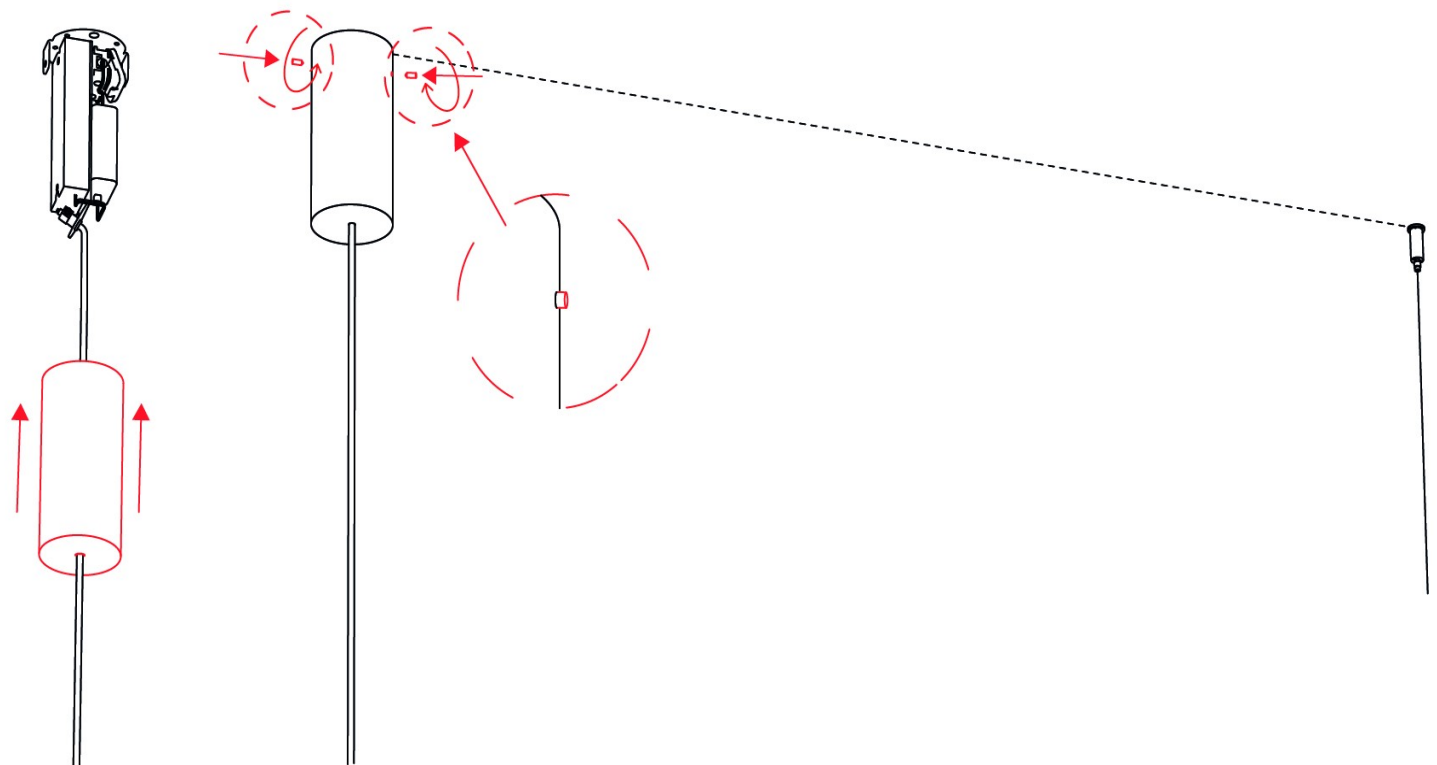

6. INSTALLING THE LIGHT

Insert the LED light source into the body of the light. Next, screw the glass shade onto the body of the light. Loosen the set screw in the sleeve on the power cable using the hex key size 1.5. Insert the connector on the power cable into the connector on the IVY light body and turn the sleeve to secure. Tighten the set screw in the sleeve. Screw the sleeve on the wire rope into the IVY light body and level the light. Make small adjustments to the length of the wire rope by loosening the wire rope stop and pressing the safety previously mounted to the ceiling. Once the light is balanced, secure the wire rope safety by retightening it. Insert the LED light source into the body of the light and screw on the glass shade. Once installation is complete, cut the wire rope, leaving approximately 5 mm protruding from the side opening in the wire rope stop.

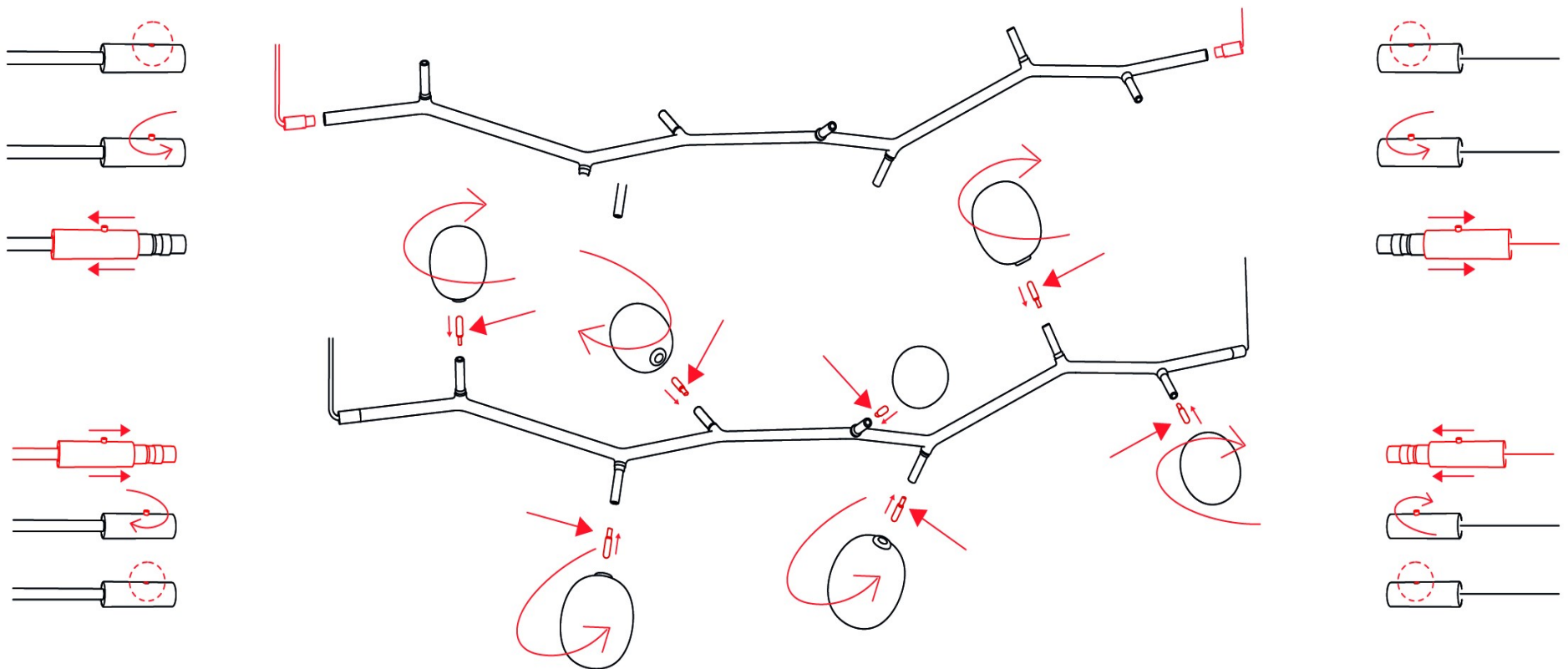

7. SWITCHING ON THE LIGHT

Restore power at the main circuit panel and verify that the light works properly.

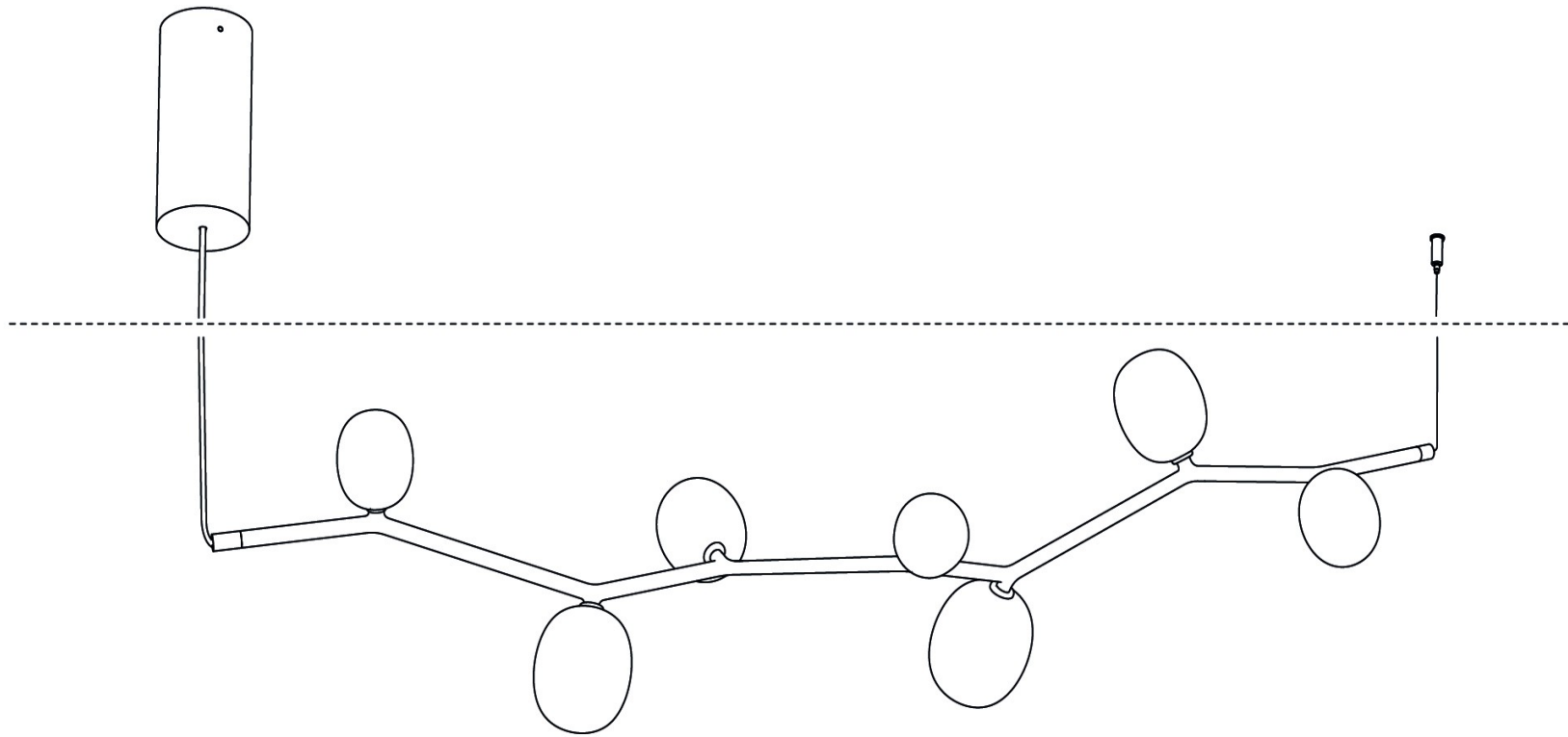

INSTALLATION MANUAL

IVY HORIZONTAL PC1069

Pendent light



The luminaire can be treated with common cleaning agents. Do not use solvents or abrasive cleaners (powders).

PRIOR TO SHIPPING, THE FUNCTIONALITY OF EACH LIGHT AND ITS COMPONENTS IS THOROUGHLY TESTED. THE MANUFACTURER ASSUMES NO LIABILITY FOR THE MISHANDLING OF PRODUCTS.



BROKIS

BROKIS S.R.O.
ŠPANIĚLOVA 1315/25
163 00 PRAHA 6 - ŘEPY
CZECH REPUBLIC

ORG. ID 64940799
VAT ID CZ64940799
C 42174 MĚSTSKÝ SOUD
V PRAZE

TEL +420 567 211 517
TECHNICAL@BROKIS.CZ
INFO@BROKIS.CZ
WWW.BROKIS.CZ