

io sospeso up datasheet

LED ceiling spotlight with spherical head and lens optics; version with surface mount transformer for fitting onto solid ceiling with cable outlet; power supply with internal power source (converter). Available as version with continuous height adjustment or fixed adjustable height. Movable in any direction thanks to Occhio 3D kinematics with two pivots set at an angle of 22.5° to each other; operation via heat-insulated grip pads. Head can be taken off for maintenance; replaceable LED. Power 18 W or 13 W (preselectable); dimmable via customer-supplied dimmable ballast or by hand movement control via touchless sensor (can be deactivated). Lighting effect can be changed through optional inserts; dichroitic color filters can be additionally inserted. Surface combinations of head, pads, body and base can be configured as desired; pads changeable.

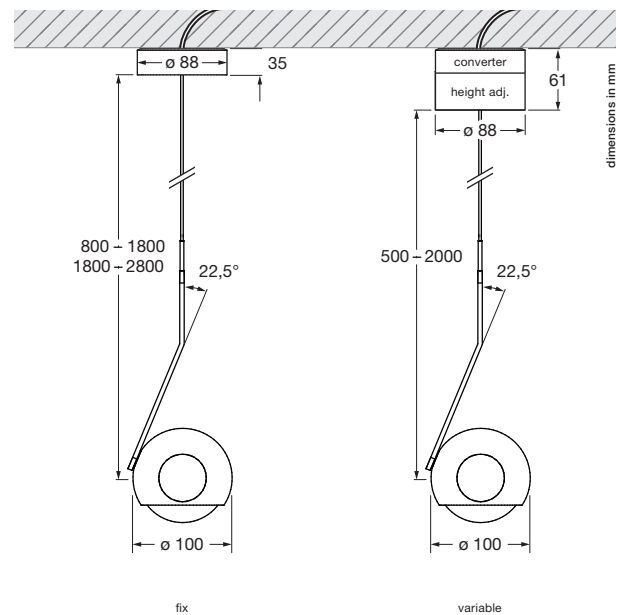

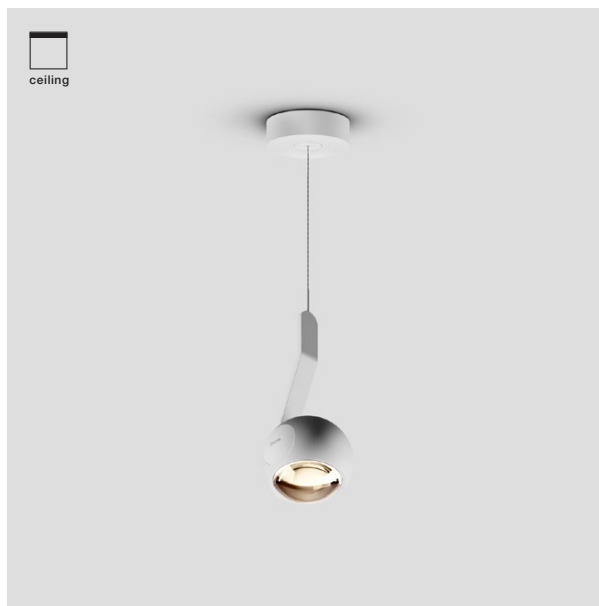

















technical data io sospeso up

properties	material	aluminium, zinc chrome-plated or painted, optical plastic, glass
	turning range head/body	360°
	length	variable: 500–2000 mm / fix: max. 800–1800 mm / 1800–2800 mm
	weight	variable: 1.5 kg / fix: 1.1 kg
surface	head	matt gold, rose gold, bronze, shiny chrome, dark chrome, matt chrome, glossy white, matt white, matt black, phantom, black phantom
	pads	rose gold, bronze, shiny chrome, dark chrome, matt chrome, glossy white, matt white, matt black
	body	shiny chrome, dark chrome, matt chrome, matt white, matt black
	base	shiny chrome, dark chrome, matt chrome, glossy white, matt white, matt black
Occhio LED	average life time	> 50.000 hrs
	energy efficiency class (luminous efficiency)	G (63 lm / W)
	power	LED 18 W (incl. Occhio power supply unit approx. 22 W, standby < 0.5 W) / LED 13 W (incl. Occhio power supply unit approx. 15 W, standby < 0.5 W)
	color rendering index	perfect color; CRI Ra 97 high flux; CRI Ra 85
	color temperature (color consistency)	2700 K, 3000 K (2-step) 3000 K, 3500 K, 4000 K (2-step)
electricity	dimming	via »touchless control« (can be deactivated), alternative with trailing edge phase-cut dimmer or Occhio air*
	power supply unit	integrated operating voltage 230 V AC
	power factor power supply (cos φ1)	0.9
	flicker / stroboscopic effect	1 (PstLM) / 0.9 (SVM)
	permitted operating conditions	ambient temperature 10–30°C, for indoor use only

* For a list of compatible dimmers, see www.occhio.com/dim_en

io sospeso up overview inserts

io head				
satinised glass				
soft edge glass				
fresnel lens				
color filter (optional, power of light source max. 13 W)				
lens				
				
	io C	io C with soft edge glass	io C with satinised glass	io C with fresnel lens

io sospeso up lighting effects

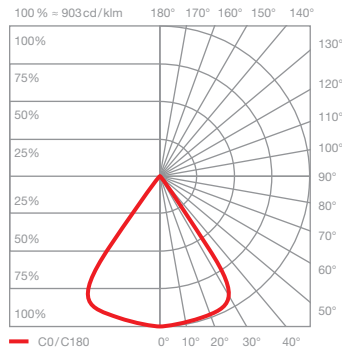
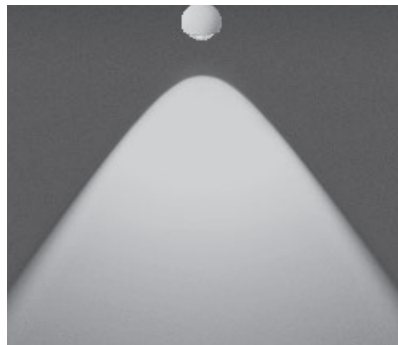

io C
directed light (approx. 80°)

inserts:	lens		
luminous flux:	perfect color	18 W	1170 lm
	high flux	18 W	1610 lm
	perfect color	13 W	800 lm
	high flux	13 W	1170 lm

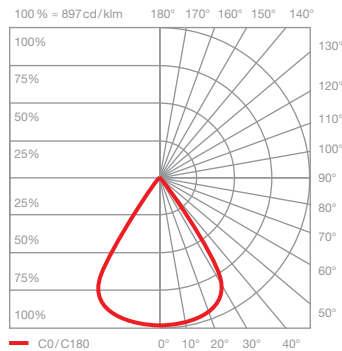
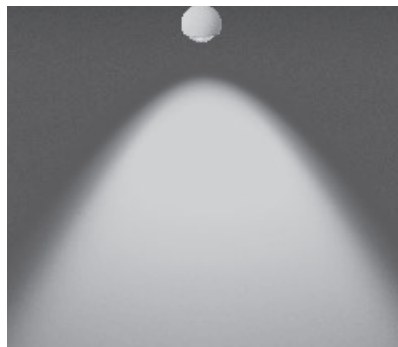

io C with soft edge glass
directed light with soft contour of the beam angle (approx. 80°)

inserts:	lens soft edge glass		
luminous flux:	perfect color	18 W	1070 lm
	high flux	18 W	1470 lm
	perfect color	13 W	740 lm
	high flux	13 W	1070 lm

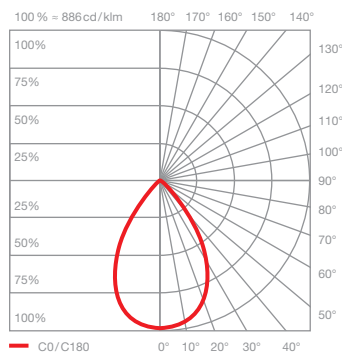
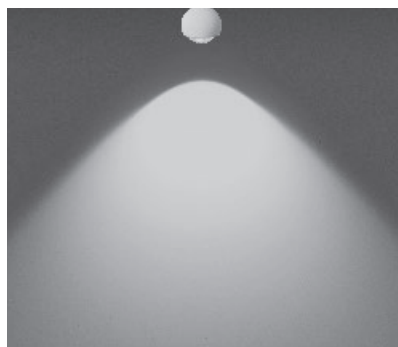

io C with satinised glass
diffused light with soft widening of the beam angle (approx. 100°)

inserts:	lens satinised glass		
luminous flux:	perfect color	18 W	910 lm
	high flux	18 W	1250 lm
	perfect color	13 W	630 lm
	high flux	13 W	910 lm

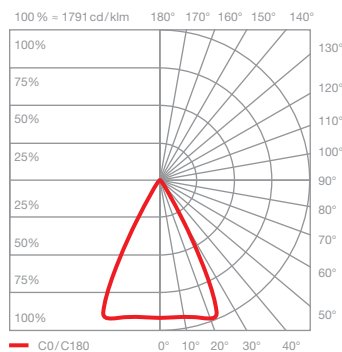
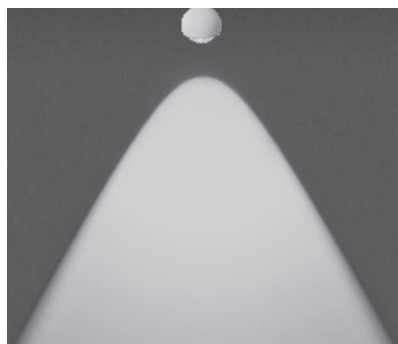

io C with fresnel lens
bundled light
beam angle approx. 60°

inserts:	lens fresnel lens		
luminous flux:	perfect color	18 W	990 lm
	high flux	18 W	1360 lm
	perfect color	13 W	680 lm
	high flux	13 W	990 lm