

Cilia pendant 40
double

Material care

Palma - Use a soft rag, or vacuum with a soft brush attachment as needed, do not wipe wet.

Powder coated Aluminum - Dust gently with a duster or soft rag. Do not use commercial cleaners.
Avoid abrasive cleaning agents.

Cuidado del material

Palma - Use un trapo suave, o aspire con un accesorio de cepillo suave según sea necesario, no lo limpie en húmedo.

Metal - Retire el polvo suavemente con un plumero o un trapo suave y seco.
No utilice limpiadores comerciales.
Evite los agentes de limpieza abrasivos.

Parts included

Partes incluidas

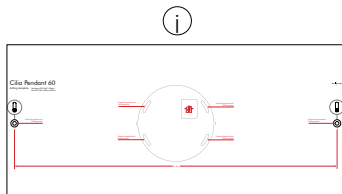
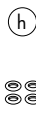
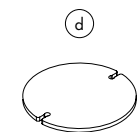
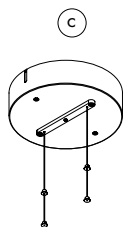
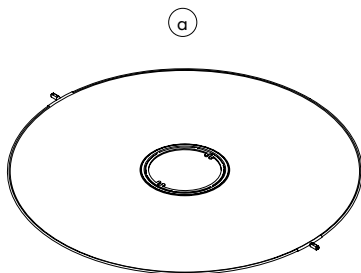

a- palma

b- lightning fixture

c- mounting canopy

d- glass diffuser

e- SMD LED module

f- cable holders

g- solid wall screws kit

h- o-rings

i- allen key kit

j- drilling template

a- palma

b- luminaria

c- canopy de montaje

d- difusor de vidrio

e- modulo SMD LED

f- sujetador de cables

g- set de tornillos para muro sólido

h- o-rings

i. set de llave allen

j- plantilla de perforado

Notes before assembly



We recommend reading the complete assembly manual before starting the installation.

Disconnect the power by turning off the circuit breaker, or by removing the fuse in the fuse box before assembling and mounting.

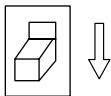

Two people are needed for installation.

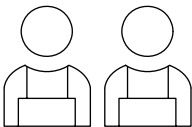

Be careful when unpacking the product to avoid damaging any of the elements. We recommend placing it on a protective surface such as a cardboard or a blanket.

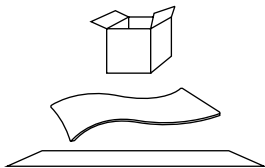

Notas antes del montaje



Recomendamos leer el manual de montaje completo antes de iniciar la instalación.

Desconecte la alimentación bajando la pastilla o quitando el fusible de la caja de fusibles antes de ensamblar y montar.

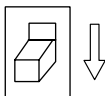

Se necesitan dos personas para la instalación.

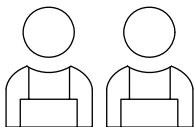

Tenga cuidado al desempacar este producto para no dañar ninguno de los elementos. Recomendamos colocarlo sobre una superficie protectora como un cartón o una manta y el uso de un par de guantes(incluidos)

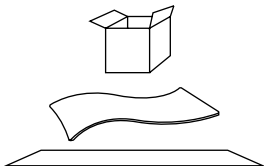



Use a 15/64" (Ø6 mm) drill bit.

Utilice una broca de 15/64" (Ø6 mm).

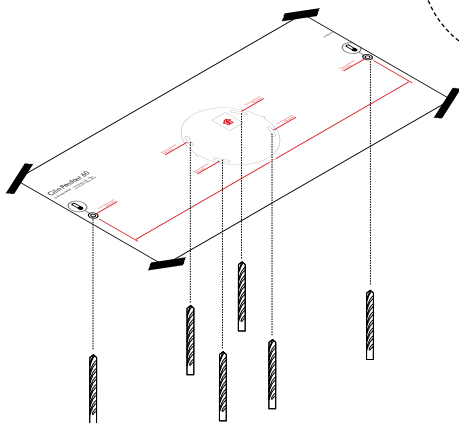
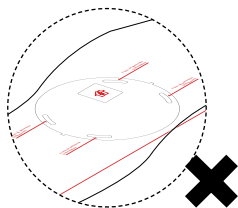
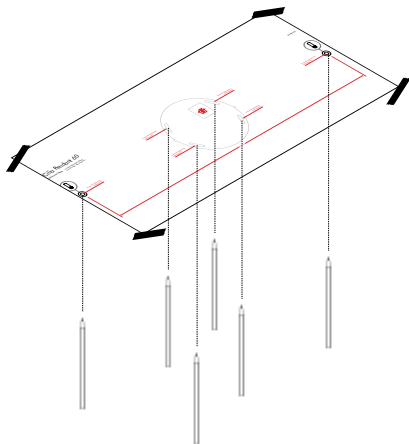

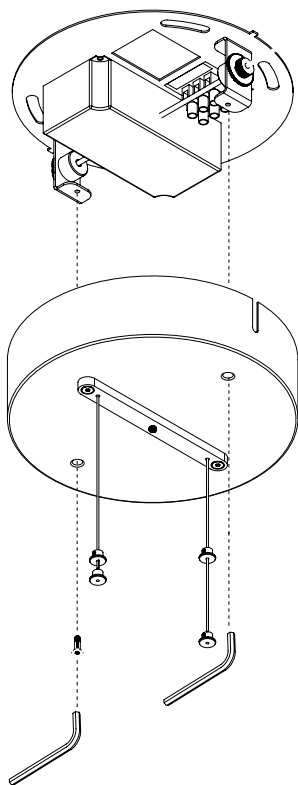



The cable holder outlets must face the canopy.

La salida de los sujetadores debe ver hacia el canopy.

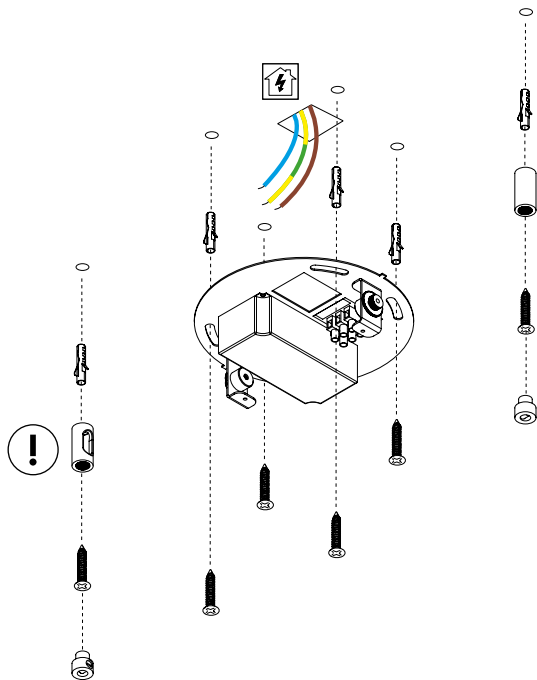

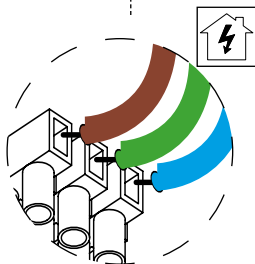
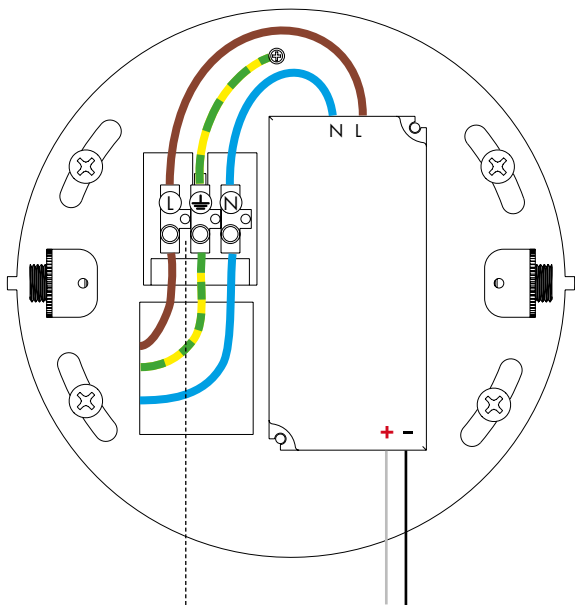

Adjust the height to the desired level using the installed technique and cable.

Ajuste la altura a la medida requerida con la técnica y el cable instalados.



The spacing between both techniques is fixed.

La distancia entre ambas técnicas no puede modificarse.

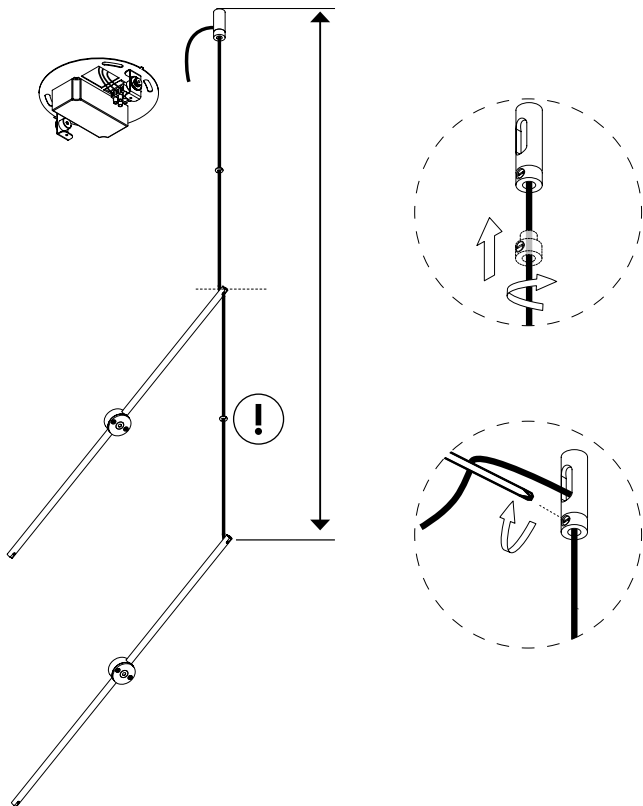



Place the de-energized cable on the opposite side,. Ensure the side with the O-rings is at the bottom.

Coloque el cable sin corriente en el lado opuesto. Revise que el lado con los O-rings quede en la parte inferior.

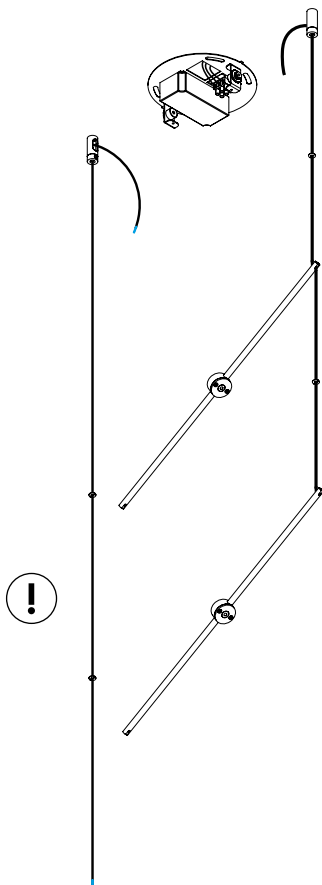



Level the de-energized cable using the o-rings as reference. Leave 5 to 10 cm free at the bottom.

Nivele el cable sin corriente usando los o-rings como referencia, deje entre 5 y 10 cm libres en la parte inferior.

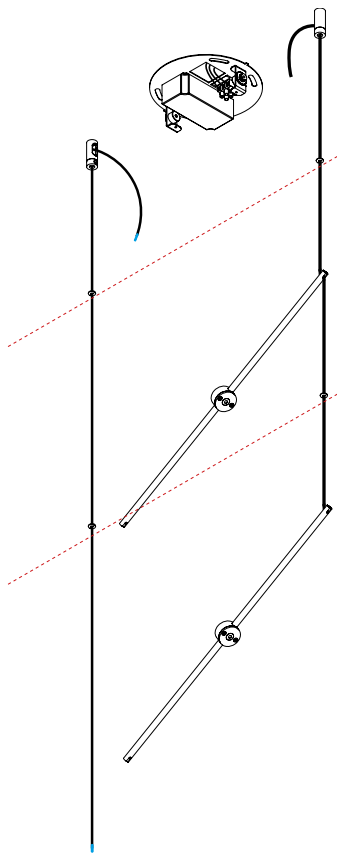
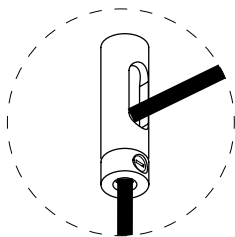



Remove the cover of the device and insert the cable to level the lamp.

Retire la tapa del mecanismo e inserte el cable para nivelar la lámpara.

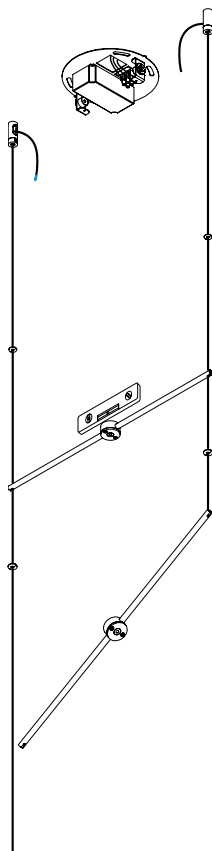
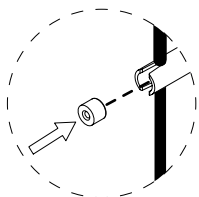
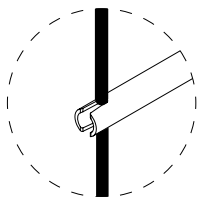
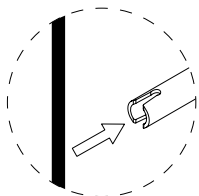
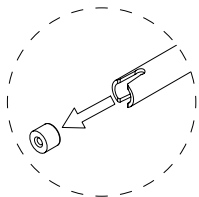



Remove the cover of the device and insert the cable to level the lamp.

Retire la tapa del mecanismo e inserte el cable para nivelar la lámpara.

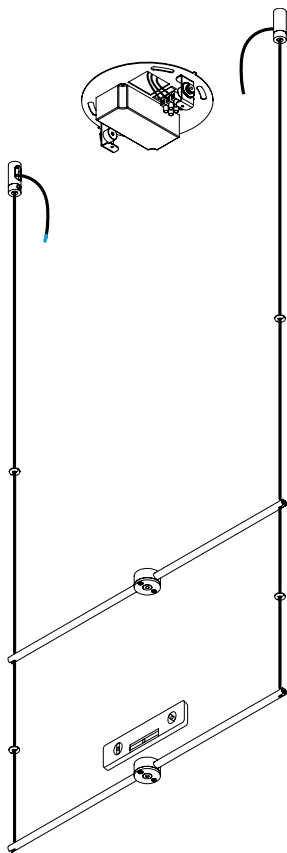
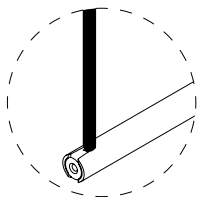
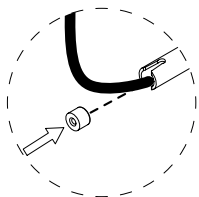
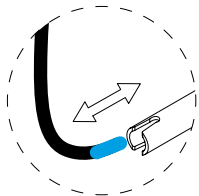
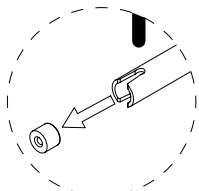



Insert both cables into the canopy's side supports and fasten them gently yet firmly using the locking clips.

Inserte ambos cables en los soportes laterales del canopy y ajústelos suavemente, pero de forma firme, con los seguros.

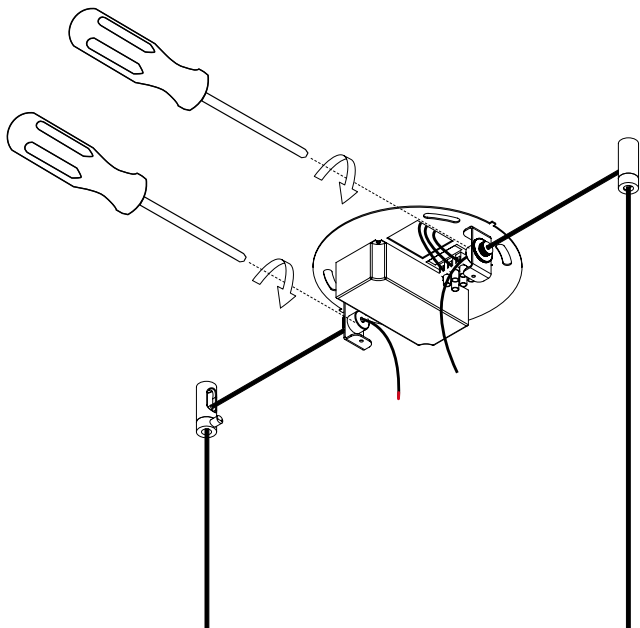



Connect only the side with the exposed cable terminals.

Conecte solo el extremo que tiene los cables con sus terminales expuestas.

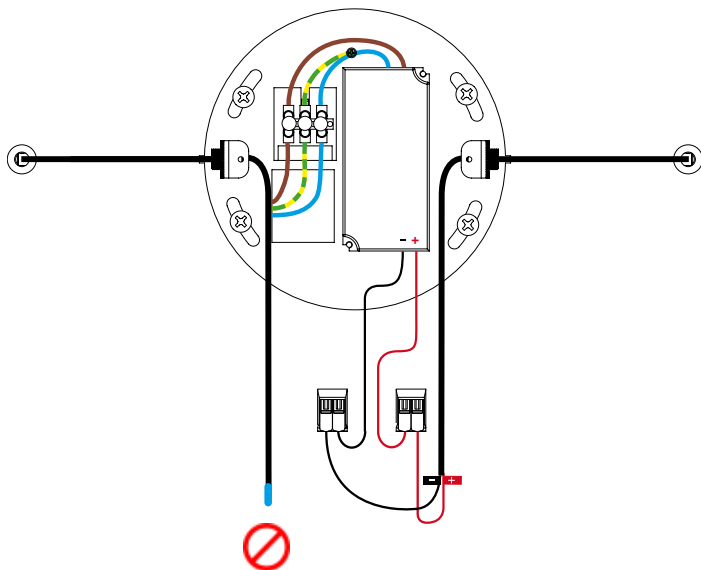

Do not connect.

No conectar.



Verify the desired height and trim the excess de-energized cable
Revisar la altura deseada y cortar el excedente del cable sin corriente.

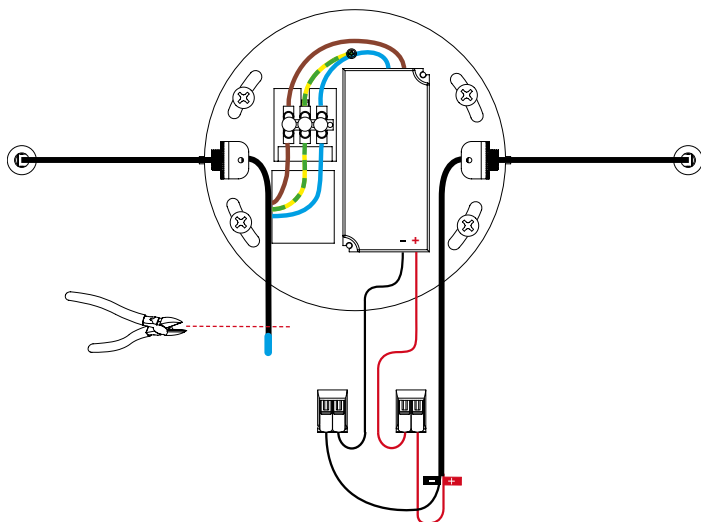

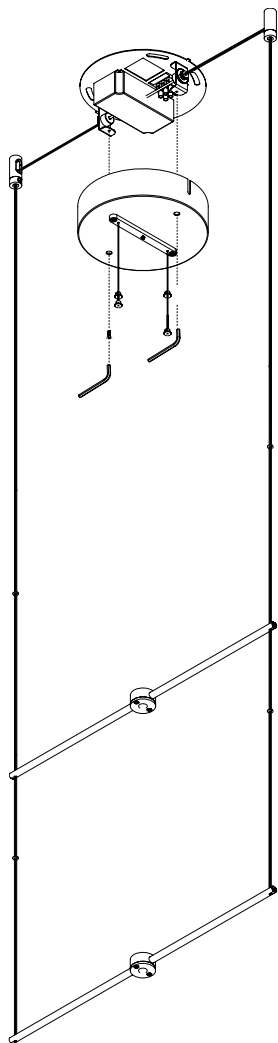



Place the cardboard guide over the o-rings on the cable. Verify that the height from the mechanism to the guide is 25 cm

Coloque la guía de cartón sobre los o-rings que lleva el cable. Verifique que la altura desde el mecanismo hasta la guía sea de 25 cm.

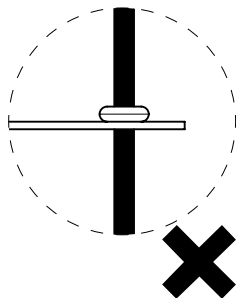
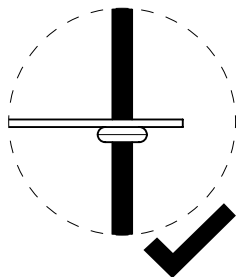
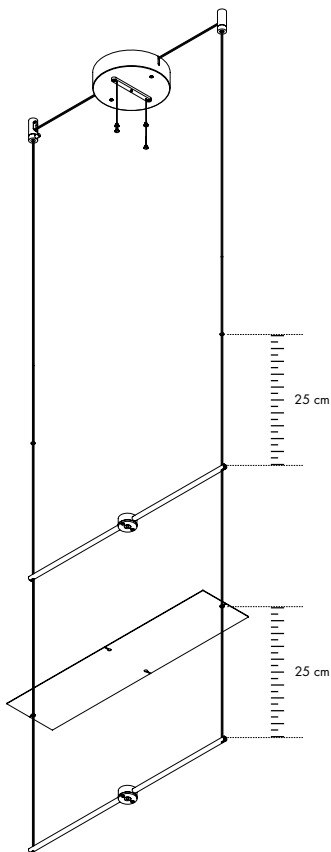



Loosen the thread and adjust the side according to the previously defined distance, as illustrated in the image.

Desenrosque el hilo y ajuste el lado que tiene la distancia previamente definida, como se indica en la imagen.

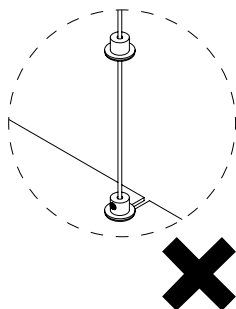
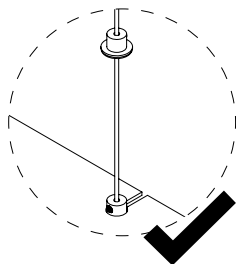
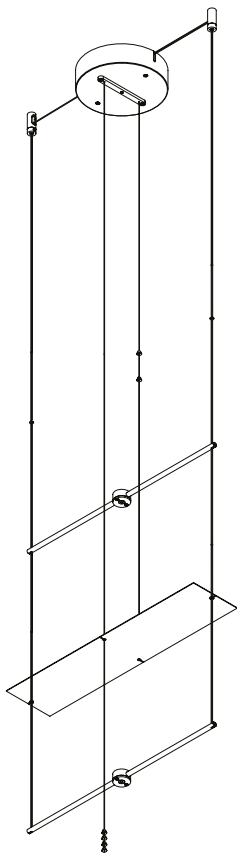



Ensure the supports are leveled to maintain the template in a horizontal position, and secure the position by fastening the supports to the canopy.

Nivele los soportes para mantener la plantilla horizontal y fíjelos en su lugar sujetando los soportes al canopy.

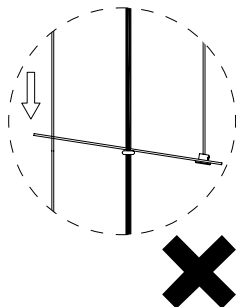
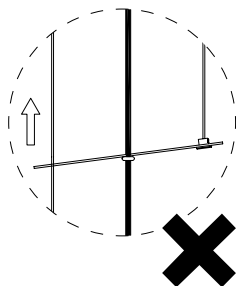
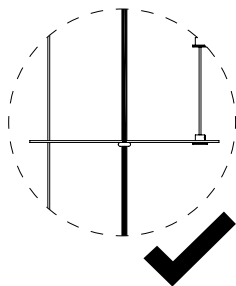
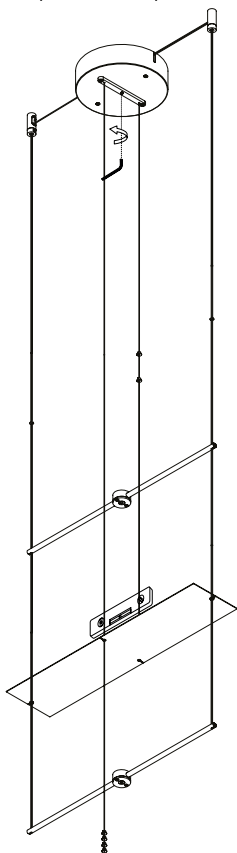



Fasten the opposite end of the thread to align it with the side that was previously adjusted.

Fije el lado contrario del hilo para igualar la posición del lado previamente ajustado.

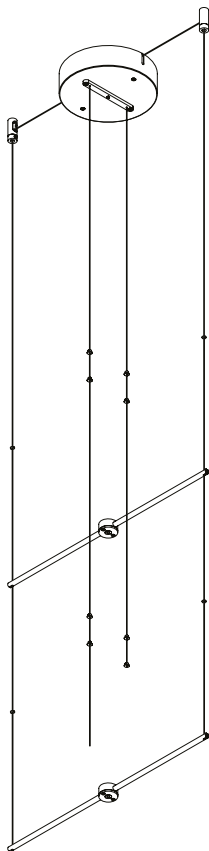
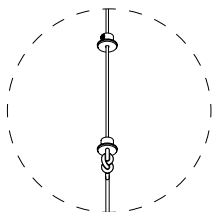
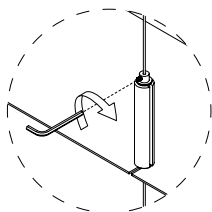
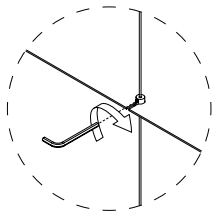

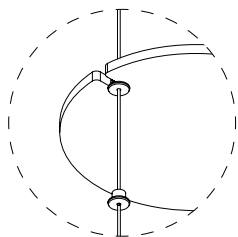
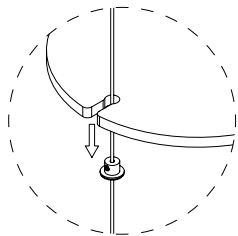
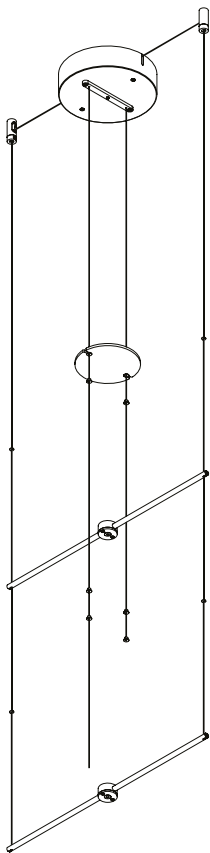

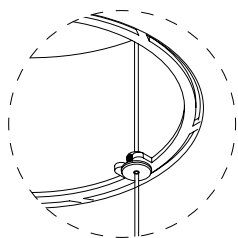
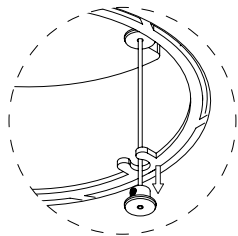
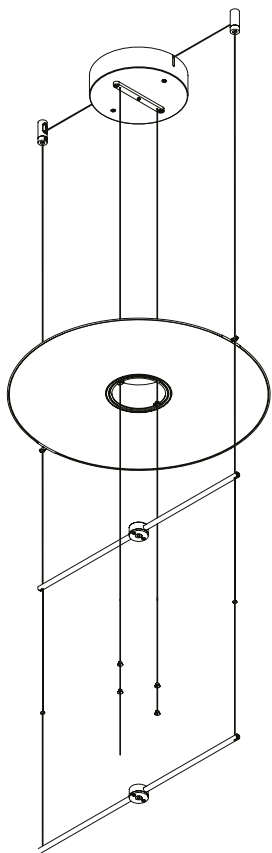

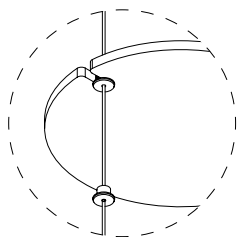
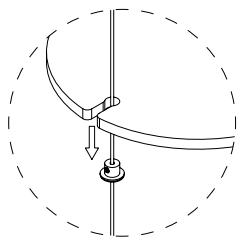
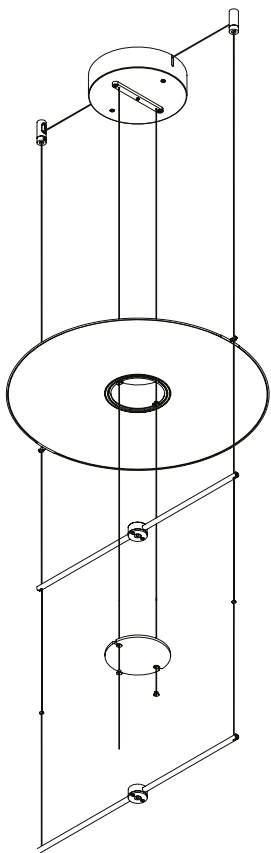

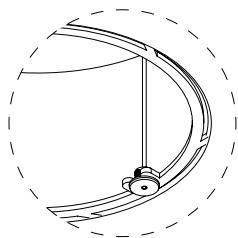
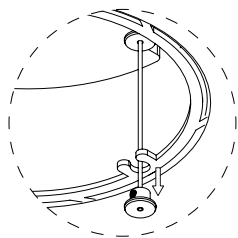
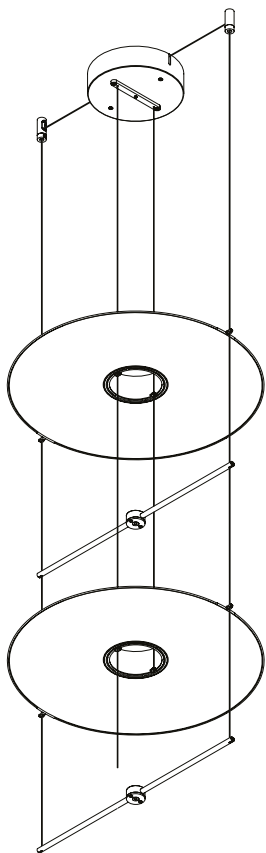



Fasten the palm using the o-ring on the lateral support

Asegure la palma con el o-ring en el soporte lateral.

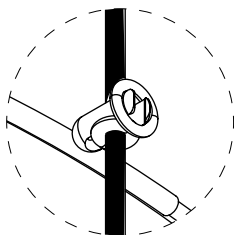
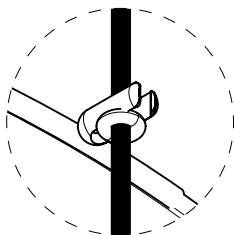
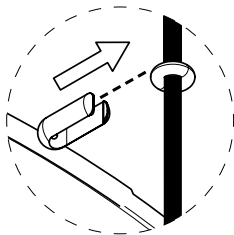
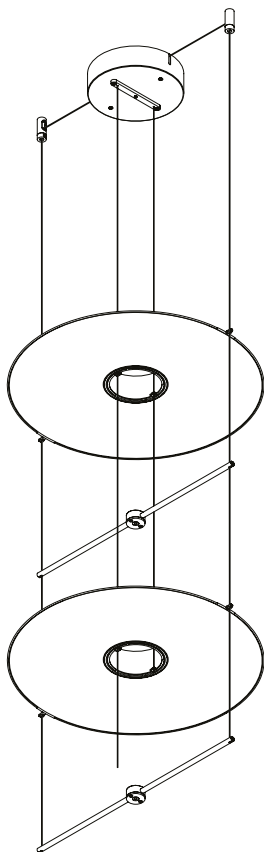

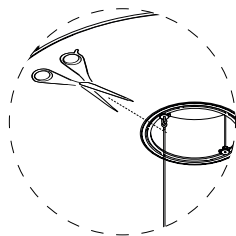
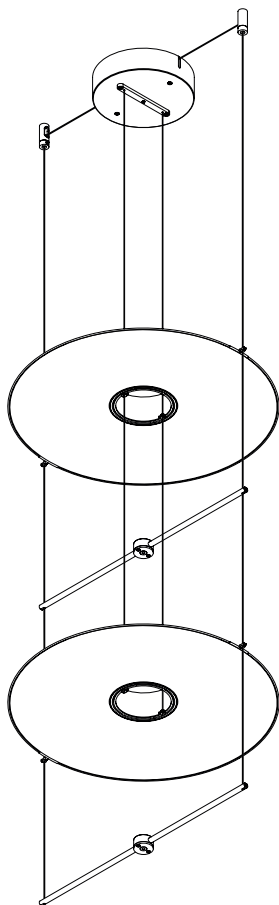



Unscrew the lock to release the thread and adjust the angle of the lamp.

Desenrosque el seguro para liberar el hilo y poder ajustar el ángulo de la lámpara.

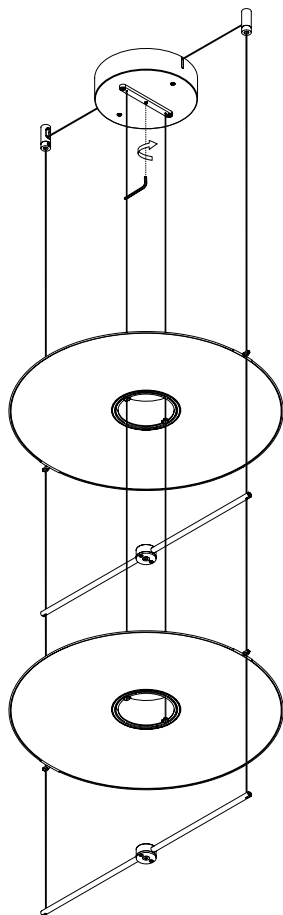

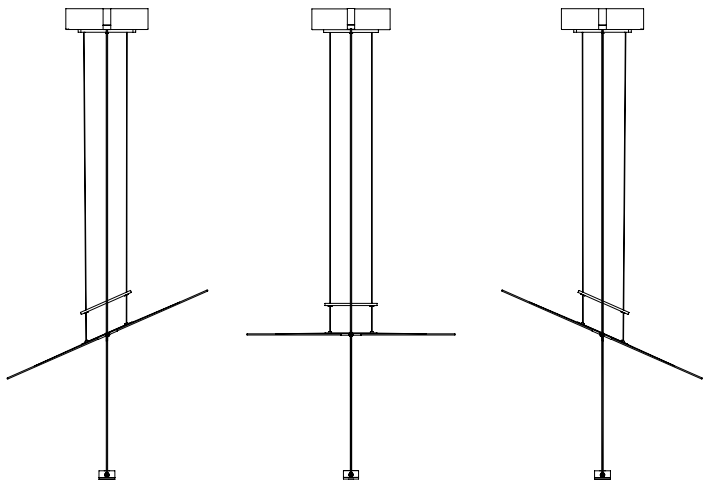

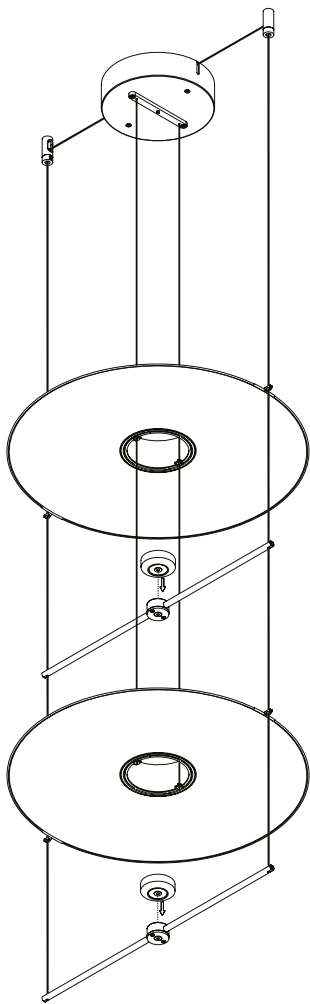



This step applies only to the spot version. (bulb not included).

Este paso aplica únicamente para la versión spot. (foco no incluido).

